

# MERINO ARMOUR

EXTERNAL WALL CLADDING

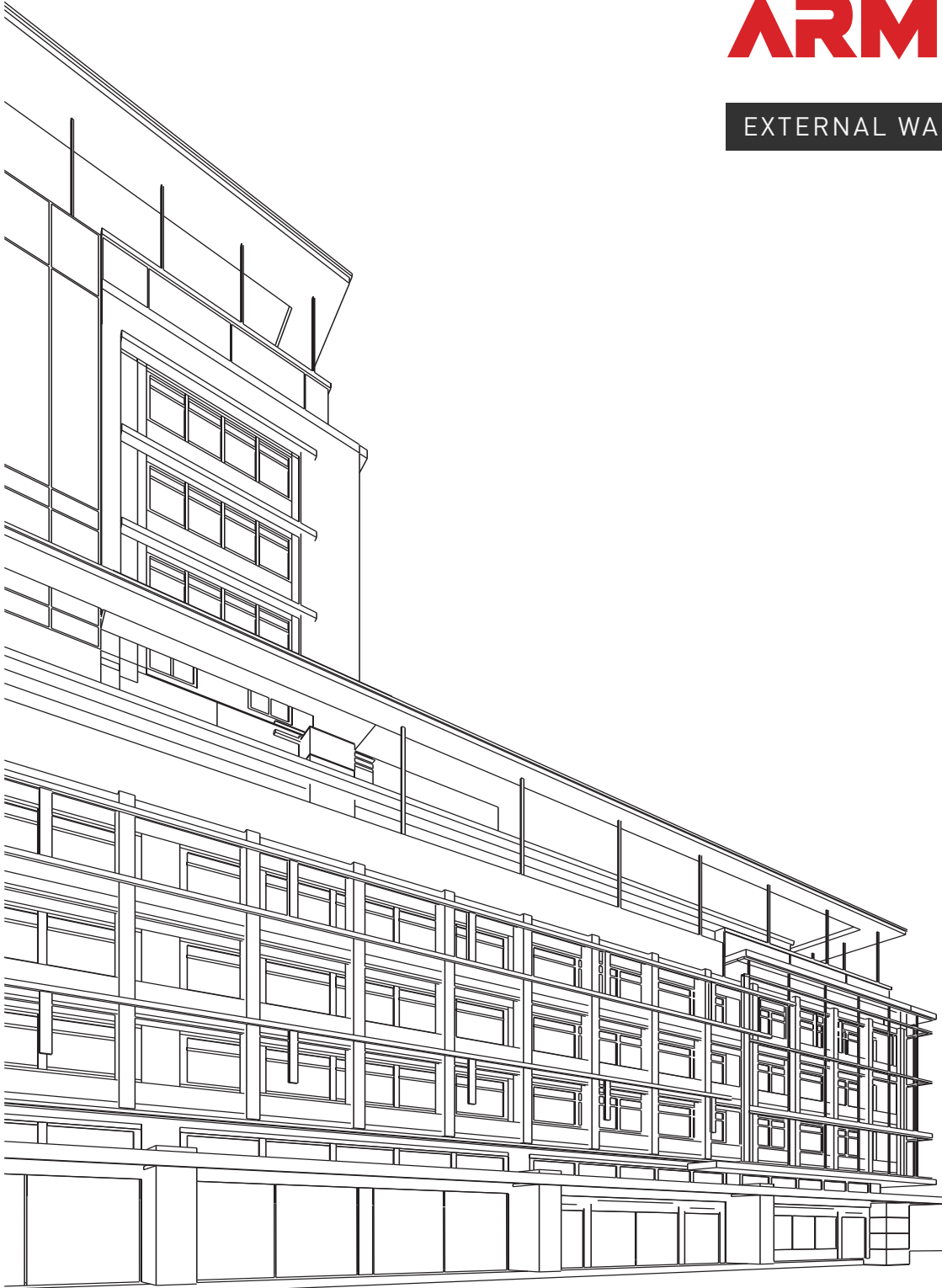

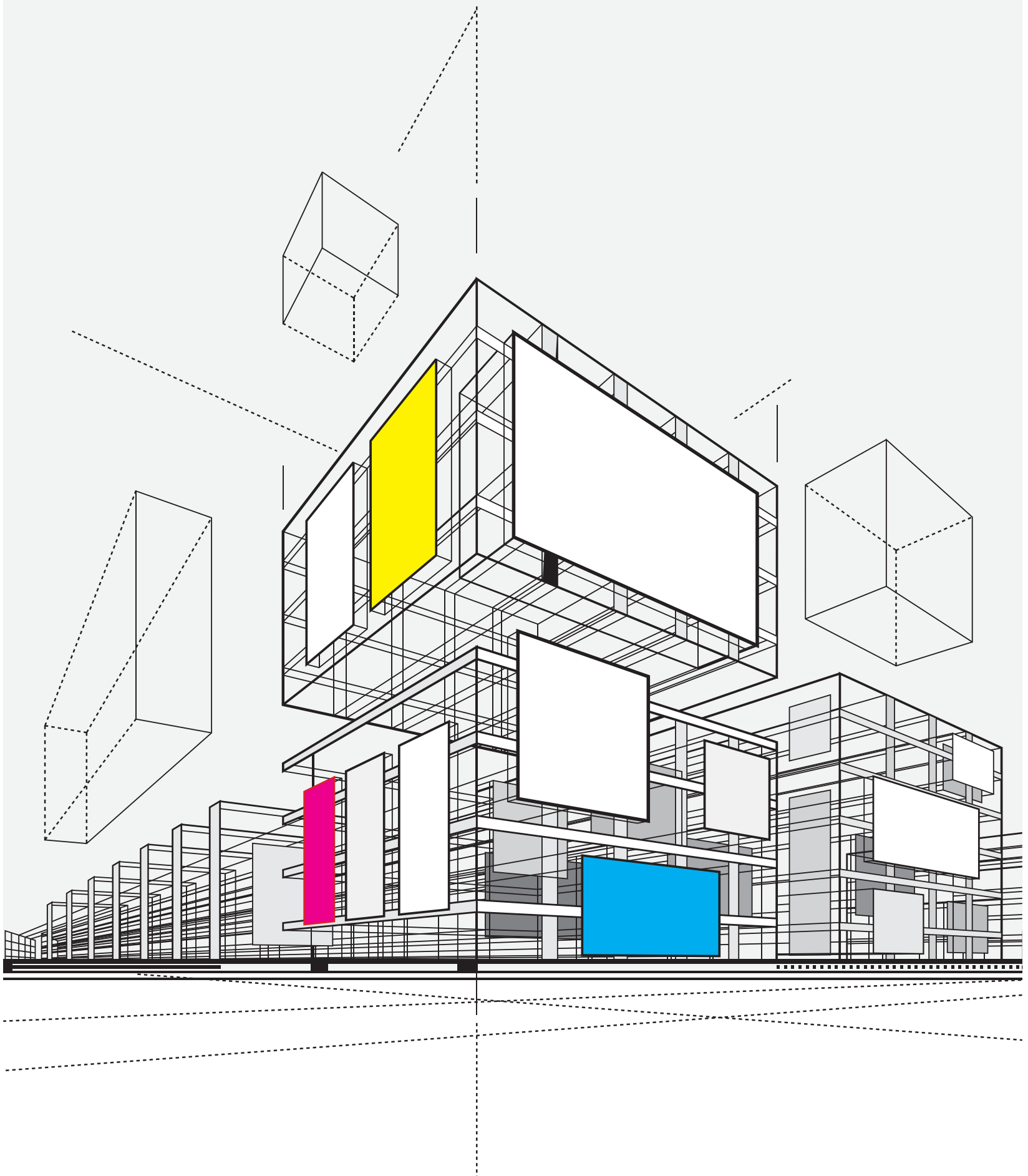

HIGH RISE  
BUILDING ▶



◀ COMMERCIAL  
BUILDING



PUBLIC  
PLACES ▶



▲  
MALL



◀ RESIDENTIAL  
APARTMENT



VILLA ▶



▲  
RESIDENTIAL  
INDIVIDUAL  
BUNGALOW

## **DISCLAIMER**

"The procedure defined in this booklet is provided for informational purposes only and should not be construed as the exclusive recommended procedure for all situations. One should not act or refrain from acting based on any procedure included in this manual book, without seeking (Façade performance Wind and Structural calculation) technical or other professional advice, as per site requirements."

**Copyright Merino Industries Limited. 2021**



## ABOUT MERINO GROUP

Since its inception in 1965, the Merino Group is a leading player in all its verticals. From the debut of its first product Plywood, in 1974 to launching high-pressure decorative laminates in 1981, Merino Group now has a global market presence in over 6 continents with an annual turnover of 280 million+ USD. The Group has diverse business interests that expand into Interior Architectural Products, Information Technology and Food & Agro Technology. With over 5000 employees, 5 production units and a significant surge in its revenue, the group continues to grow in a rapidly changing and ever-evolving market. With multiple surface solutions having endless design possibilities, Merino ensures a consistent range of superior quality products. With innovation at its core, the Merino Group commits to the highest manufacturing standards with a strong customer support.

## PROOFS OF EXCELLENCE

At Merino, maintaining quality is a tradition which is lived with a passion. We encourage the adherence to safety standards, promote ease of application, strive to reduce installation time, and customers maintain their interiors with relevant usage information.



## INTRODUCTION

Merino Armour External Wall Cladding is an exterior grade decorative high pressure laminates. It acts as an envelope of the building and also provides aesthetic appeal to it. It is specially treated with acrylic resin and electron beam curing, thus providing it with weather resistance and UV resistance. The range has multiple design configurations, sizes, shapes, and is optimized for multiple applications including residence, shopping malls, hotels, apartments, office buildings, retail, airports etc. The EWC range is powered with high levels of resistance to weather, UV rays, climatic shock, corrosion, graffiti, pollutants and abrasion.

## ARMOUR RANGE: GRAIN & PATTERNS

- UV RESISTANT FILMED LAYER
- MELAMINE COATED DECORATIVE PAPER
- KRAFT PAPERS
- MELAMINE COATED DECORATIVE PAPER



UV Resistant Filmed EWC range (EGS grade)



## SUPERCLAD RANGE: SOLID/PLAINS

- HIGH UV ABSORBER ENRICHED 3 LAYERS OF ACRYLIC
- POLY URETHANE (PU), LAYER
- MELAMINE COATED DECORATIVE PAPER
- MELAMINE TREATED BARRIER PAPER
- KRAFT PAPERS
- MELAMINE COATED DECORATIVE PAPER

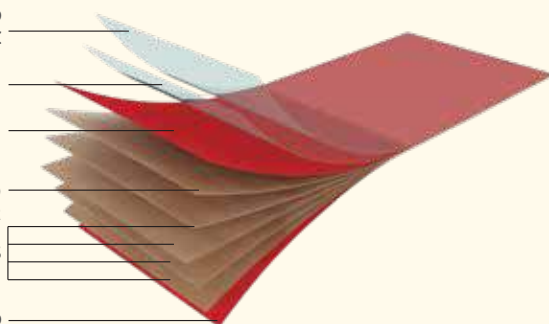

Superclad Technology In EWC Range (EDS grade)

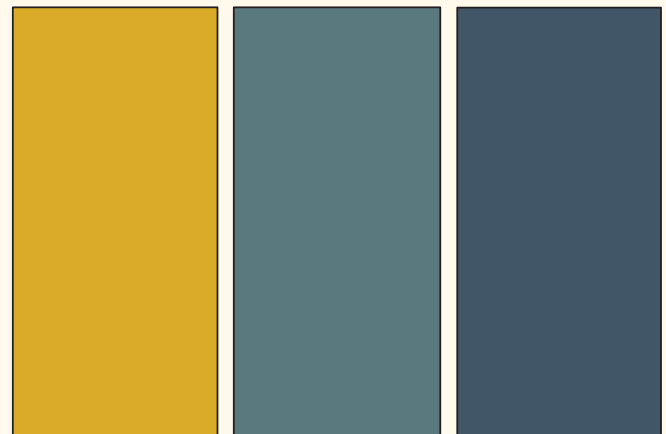

## MERINO ARMOUR ENERGY SAVING SYSTEM

The extensive range of External Wall Claddings blends strength and beauty to perfection. The Armour epitomizes a weather resistant envelope to enhance the lifespan of your building as it can endure all weather fluctuations like intense heat, heavy showers, chilly winters that India experiences. The main advantage of Armour ventilated facade systems is energy saving. The correct design and implementation of the systems reduce energy losses and increases the comfort of the living environment.

**Ventilated Façade:** Natural ventilation and vapour permeability are also very important for the inner microclimate. The gap between the wall and Armour EWC allows air to circulate and protects the building from overheating during the summer and cooling down during the winter.

The ventilated façades allow the building to breathe and eliminate the condensation inside the building. The thermal insulation let the construction moisture evaporate, and in the building with higher humidity to be released outside.

**Energy Saving:** A natural insulation i.e. an air cavity gets created between the wall and the External Wall Cladding. This air gap facilitates continuous air ventilation that reduces heat or moisture effect on the base structured wall and this ventilation process contributes to reduced levels of energy losses and consumption, and also avoids corrosion of the exterior surfaces, thus it allowing retention of indoor temperature. The buildings are now better ventilated providing a more comfortable indoor environment and ensuring significant energy saving.

**Flame Retardant:** The most important advantages of Armour ventilated systems is, the Armour have Flame Retardant properties which allows it to withstand against the flame, according to the European regulations for fire safety. The combination between Flame Retardant Armour façade materials and specially designed systems by Façade Expert, additionally increases the safety advantages of the building.

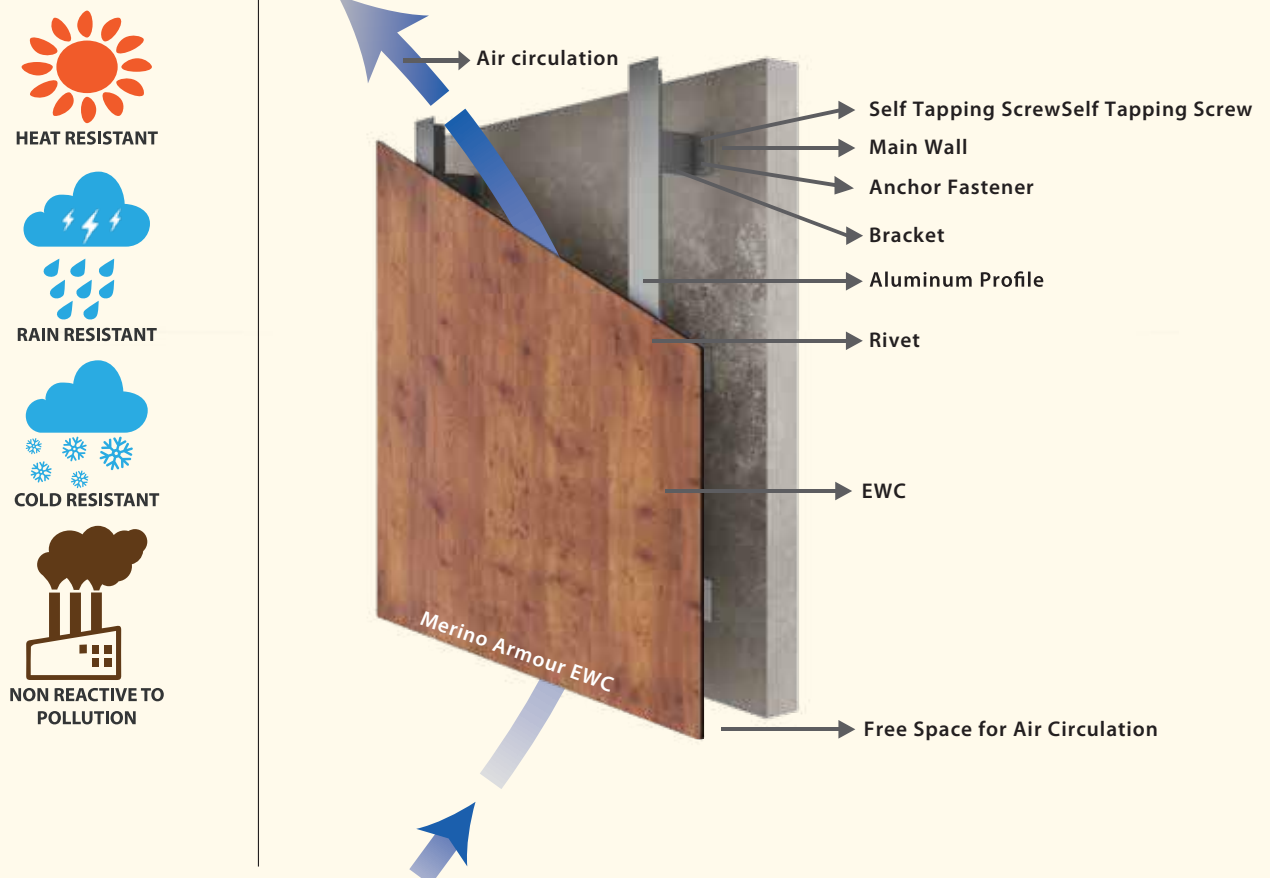

**Technical Specifications**  
**Technical Data Sheet**

PROPERTIES	TEST METHOD	ATTRIBUTES PROPERTY	UNIT	EWC	
				Standard Value	Actual Merino Armour EWC value
Thickness	EN 438 2-5	6.0 ≤ e < 8.0	mm	Tol ± 0.4	Tol ± 0.4
Length & Width	EN 438 2-6	Panel	mm	+10-0	+10-0
Edge Straightness	EN 438 2-7	Panel	mm	≤ 1.5	< 1.5
Squareness	EN 438 2-8	Panel	mm/m	≤ 1.5	< 1.5
Flatness	EN 438 2-9	6.0 ≤ e < 8.0	mm	≤ 5.0	< 5.0
Density	ISO 1183	Mass	g/cm <sup>3</sup>	≥ 1.35	> 1.4
Wear Resistance	EN 438 2-10	Abrasion Resistance	Revolution	350	> 400 Rev.
Impact Resistance	EN 438 2-21	Dropped ball e ≥ 6 mm	mm	1800 m (Large Diameter Ball) height-no crack height 10 mm Max.	1800 m (Large Diameter Ball) height-no crack height 10 mm Max.
Dry Heat Resistance	EN 438 2-16	Resistance to Dry Heat at 180°C	Appearance	Min. Level 4	Level 5
Resistance to Boiling Water	EN 438 2-12 T ≥ 5.0 mm	Moisture Resistance	% Mass Increase	Max. 2% in weight	rW = 0.8%
			% Thickness Increase	Max. 2% in thickness	rT = 0.8%
			% Mass Increase	Level 4	Level 5
			% Thickness Increase		

**Mechanical Properties**

Exterior Grade Compact Laminate - Merino Armour EWC

PROPERTIES	TEST METHOD	ATTRIBUTES PROPERTY	UNIT	EWC	
				Standard Value	Actual Merino Armour EWC value
Modules of Elasticity	ISO 178	Strength	Mpa	≥ 9000	≥ 9000
Flexural Strength	ISO 178	Strength	Mpa	> 80	≥ 90
Tensile Strength	EN ISO 527-2	Strength	Mpa	≥ 60	≥ 70

**Weather Resistance**

**Technical Data Sheet**

PROPERTIES	TEST METHOD	ATTRIBUTES PROPERTY	UNIT	EWC	
				Standard Value	Actual Merino Armour EWC value
Light Fastness	EN 438 2-27	Contrast	Grey Scale	Min. Level 4	≥ Level 4
Artificial Weathering	EN 438 2-29 : 3000h	Contrast Appearance	Grey Scale	Min. Level 3	Min. Level 3
			Grey Scale	Min. Level 4	Min. Level 4
UV - Light	EN 438 2-28 : 1500h	Contrast Appearance	Grey Scale	No Requirement	For EGS only
			Grey Scale	No Requirement	For EDS C-3, A-4
Dimensional Stability	EN 438 2-17	Accumulated dimensional change	%	L: Max 0.3%	< Max 0.3% (L)
At elevated temperature				L: Max 0.6%	< Max 0.6% (W)
Resistance to climate shock	EN 438 2-19	Appearance	Rating	Min. Level 4	Level 5
		Flexural strength Index Ds	Index	Min 0.80	For EDS 0.92
		Flexural modulus Index Dm	Index	Min 0.80	For EDS 0.84

**Fire Resistance**

Reaction to Flame ASTM E-84 Flame Retardant Flame Characteristics

PROPERTIES	TEST METHOD	ATTRIBUTES PROPERTY	UNIT	EWC	
			Classification	Standard Value	Actual Merino Armour EWC value
Flame Characteristics (For FR Grade EWC)					
Reaction to flame	ASTM E-84	Flame retardant	Class 1	FSI 0-25	FSI 25
				SD Max. 450	SD 40

## STACKING OF ARMOUR EWC PANELS

When it comes to compact laminate boards stacked at the top or bottom, warpage issues are commonly observed. However, if one follows the proper precautions during storage, the problem of warpage can be avoided. Please remember that even a small difference in moisture absorption between the two sides of compact laminate board could result in immediate warpage as these boards have extremely high density.

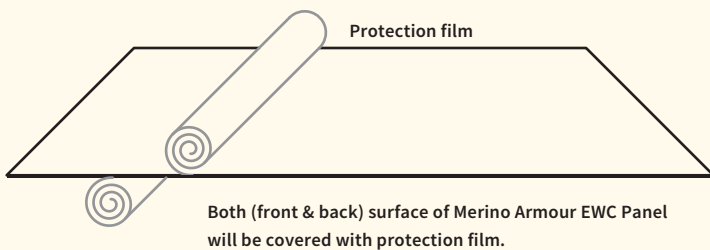
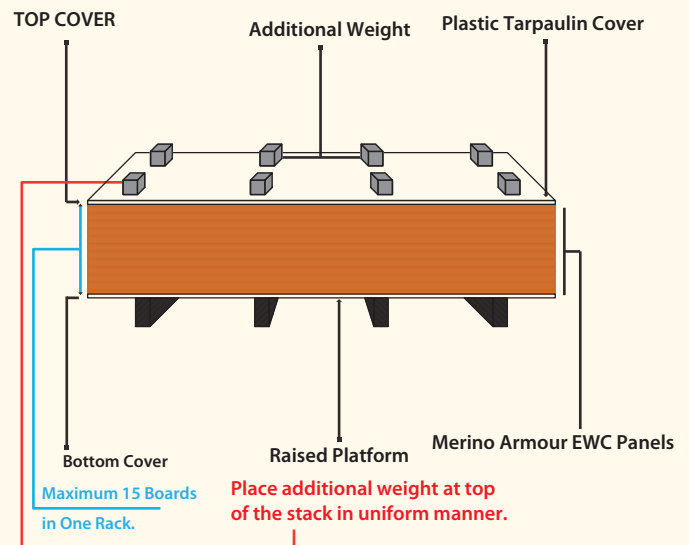

- It's important to observe a few safe practices while stacking Merino Armour EWC Panels. The surfaces of all laminates except the top and the bottom should be covered. Place one ply at the bottom and similarly follow the same procedure on top with some load on the top cover.

- Merino Armour EWC Panels must be stored in stocks of up to 15 boards by one sheet of ply each at the bottom.
- A little additional weight in a constant manner must be placed on top of all cases at appropriate places.

## ARMOUR PANELS MUST BE ALIGNED WITH EACH OTHER IN A RACK OR PALLET.

Merino Armour EWC Panels that are stored in piles should be aligned with each other and no sides of the laminate should be found protruding.

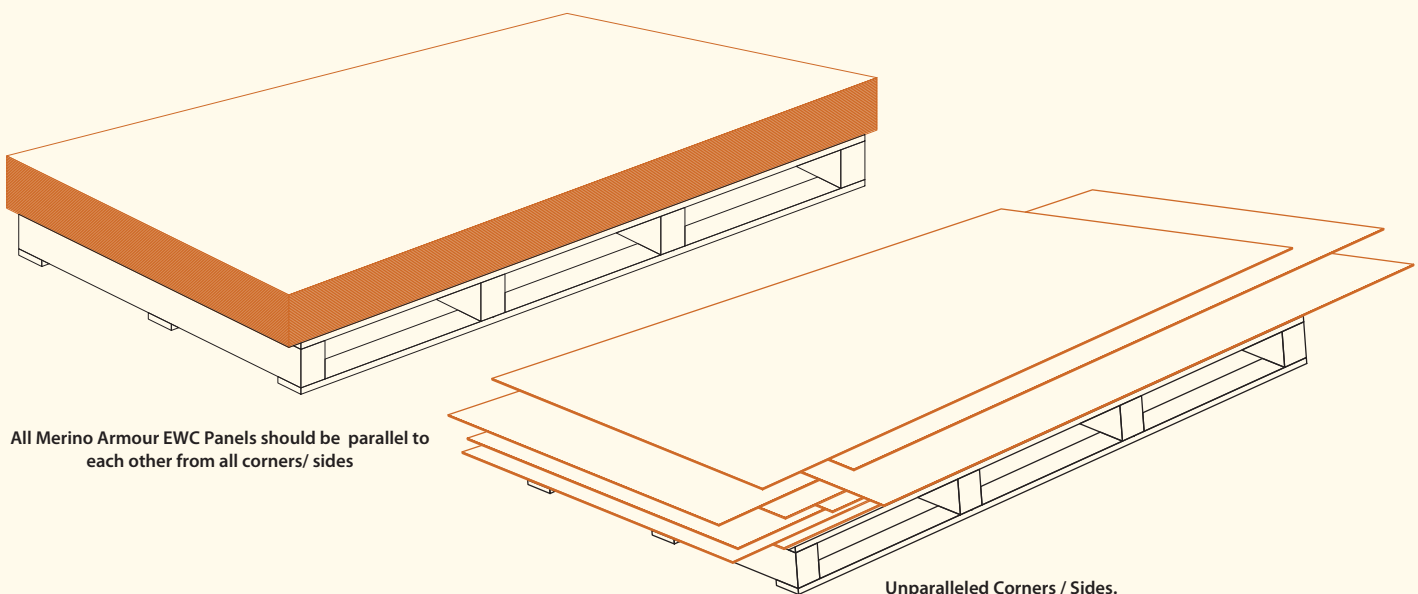

## TRANSPORT

During transportation, the panels must be handled with utmost care, in order to avoid damage to the edges and decorative surfaces. Hence, the following precautions must be taken.

- To prevent distortion or damage, Merino Armour EWC panels must be stored horizontally on a flat and supporting pallet.
- Place a protective sheet between the pallet and the first panel. In order to protect the surface, keep one on top of the stack.
- To prevent damage, slippage and toppling, attach the panels to the pallet using steel or nylon straps. Make sure that it is firmly fixed. The edges and corners must be secured too.

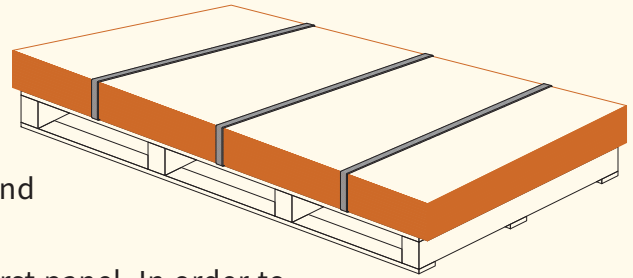

## LOADING AND UNLOADING

- During loading and unloading of panels, ensure that they don't slide over each other.
- Lift them using your hands or a lifting system with suction cups and then transfer them to another location.

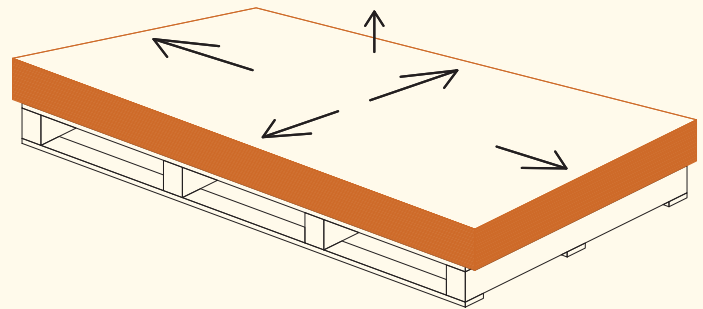

## STORAGE

- If stored incorrectly, permanent deformation of the panels can take place.
- Store the panels horizontally on top of each other. Make sure that they are stored on a flat surface.
- Panels must not be made to stand on their edges.
- Use a sheet of polythene or other protective material to cover the outermost panel.

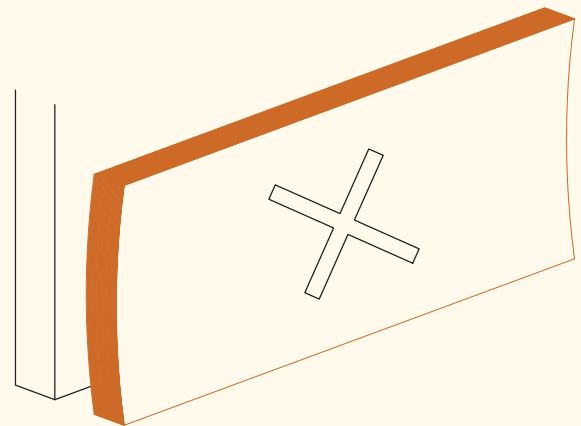

## FOR TEMPORARY STORAGE OUTSIDE

- Provide protection to the panels against various climatic conditions by covering them with polythene or tarpaulin.
- This will help in preventing moisture ingress in between the sheets.
- The delivered material must remain fasten and covered on the pallet until usage.
- After opening the pallet and using the material, a polyethylene sheet must be placed over the top sheet and re-strapped.
- The pile of sheet must be covered with polythene or water proof tarpaulin.

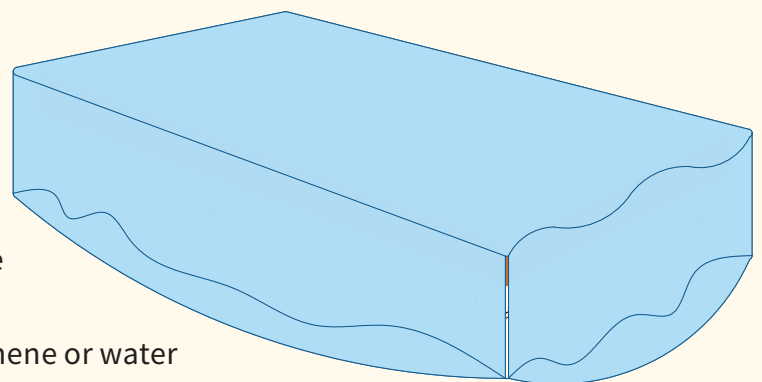

- The above precaution is of critical importance, especially if the protective film has been removed.
- Keep the pallet in a well-drained area, so as not to place it wet or damp conditions.
- Do not place the pallet over loose soil as these areas have higher ambient humidity.
- Re-stack the panels in the same manner that they were received from the warehouse, if they were manufactured in a workshop.
- The above is also applicable for panels which have been pre-prepared in the workshop by affixing hanging brackets etc.
- The panels which have distorted in shape due to moisture absorption should be positioned on hard wooden slats, placed between the panels, with a maximum distance corresponding to a value less than 20 %.
- Panels must be kept in parallel and fastened when not in use and covered in a well-ventilated manner with polythene or tarpaulin.

## FOR STORAGE INSIDE

- We suggest you to store the Merino Armour EWC panels in a closed warehouse under (normal temperature 10-30°C humidity 40 to 65%).
- While they are inside the warehouse, place the Merino Armour EWC panels horizontally together, on a strong, well-supported flat rack.
- Please make sure to provide a protective sheet between the supporting rack and the first panel.
- Protect the top panel by covering it with a sheet, and on top of that keep a larger panel that has sufficient mass to exert a downward pressure on the pile of Merino Armour EWC panels.

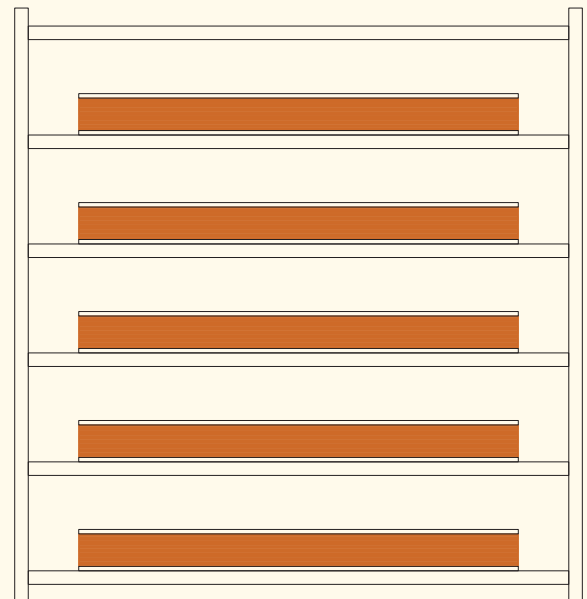

## ACCLIMATIZATION

- We suggest you to leave the panels in a well-supported ventilated position before processing - at least for a period of 1 day per mm thickness. This will allow them to acclimatize, in order to prevent any distortion of the panels.

## PROCESSING CONDITIONS

- The processing of Merino Armour EWC panels in the workshop must take place under normal conditions.
- Please ensure that machine surfaces are clean before laying the Merino Armour EWC panels on them.
- The light inside the room must be bright and the room must provide adequate dust extraction so that you are able to view the Merino Armour EWC panels correctly during processing.
- Check the ARMOUR panels for any production defects before you start processing.
- On witnessing any production defects in the panels, use the complaints protocol to report them to the supplier. The supplier will then contact the Merino technical representative.



- Merino is not obligated to compensate you for processing panels that might have a production defect.
- For Merino Armour EWC wood panels, make sure to match the wood grain as per the design.
- In case of Merino Armour EWC Concrete panels, make sure to match the decorative pattern as per the design.
- Turning the panels through 90°, 180° and or 270° can result in a noticeable colour distinction. Take extra care with the direction of all Merino Armour EWC panels and in particular with the Merino Armour EWC Metal typology.

## PANEL EDGE FINISHING

- We recommend to finish-mill the edges of the panels after sawing for better output. This will help in making it as smooth as possible to prevent water accumulation.
- To prevent burring, which in turn causes water and dirt accumulation, the edges of the panels should be chamfered at the visible side of the panel.

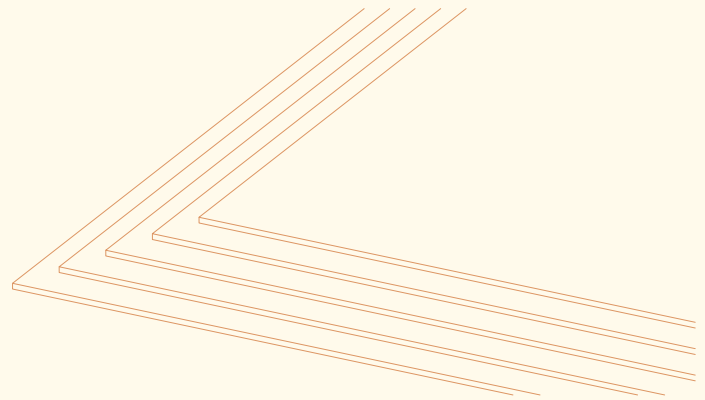

## PROTECTION FILM

- The Armour comes with a protective film, applied from both sides of the panel.
- Please note that it is of utmost importance to rip the film off the surface at the same time on both sides together. For example, keeping the protection film just on the outer side of the panel in order to protect the surface from dirt and risk of damage is not appropriate. This would cause a distortion of the panel while assembling the facade.

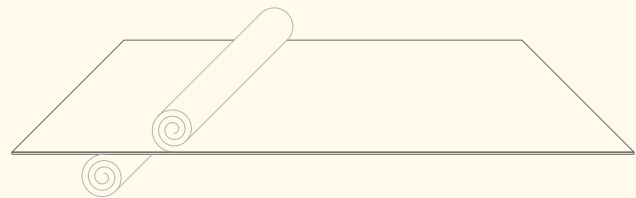

## TYPES OF TEETH

- **Trapezoid:** Preferred for high abrasive surface
- **Trapezoid:** Preferred for high abrasive surface
- **Flat:** Preferred for processing of Merino Panels
- **Pendulum:** On machines with no scoring units
- **Variable:** Alternate of Flat tooth
- **Concave:** Similar to pendulum with longer machine life with no scoring units

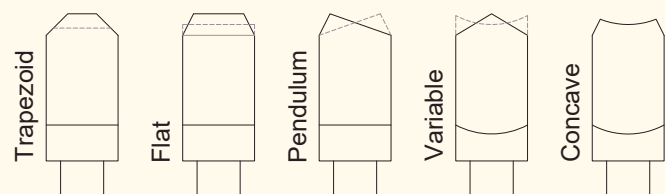



During the process, ratio of number of teeth (Z), feed rate (vf) to cutting speed (Vc) should be need)

Tool	Vc	Fz
Equipment's	m/s	MM
Saw	40 - 60	0.02 - 0.1
Mill	30 - 50	0.3 - 0.5
Drill	0.5 - 2.0	0.1 - 0.6

### Calculations

$$\text{Cutting speed} = \frac{(\text{Diameter of tool}) * (\pi) * (\text{Rotational speed of tool})}{60}$$

$$\text{Feed speed} = \frac{(\text{Tooth feed}) * (\text{Rotational speed of tool}) * (\text{No. of teeth})}{1000}$$

## CUTTING

The saw blade will need to be adjusted to a higher level and to a lower level for an unclean cut of the underside, in case the upper cutting edges are unclean. The thumb rule is to plan to have continuously two full teeth in the thickness of the panel. The blade overhang, entrance and exit angles decide the quality of cutting edges. The best way to determine height adjustment is to observe.

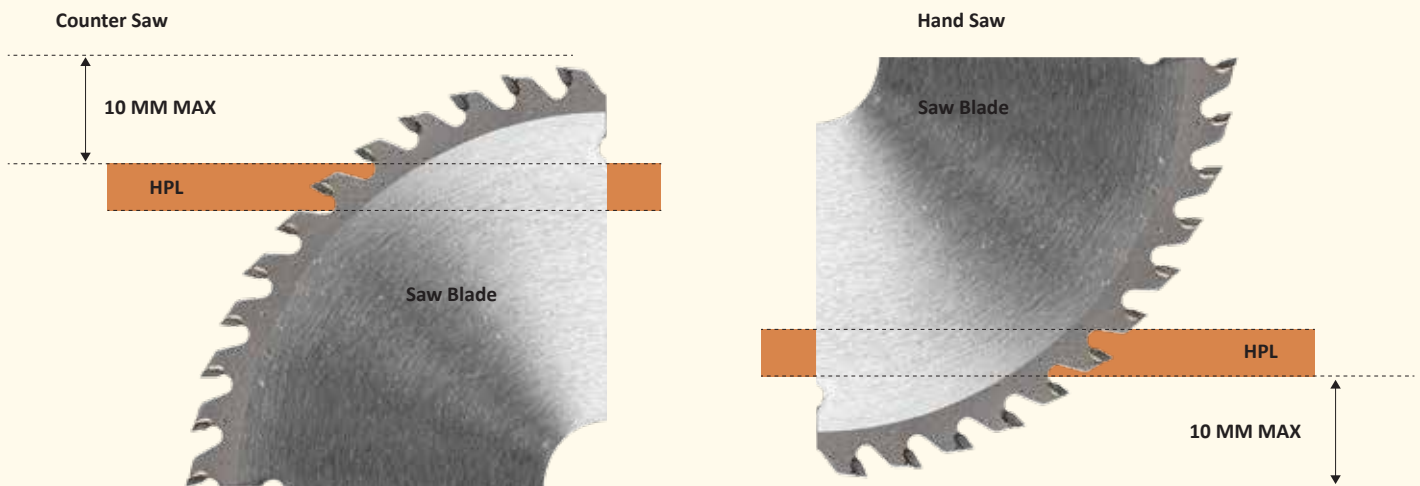

## DRILLING

- We suggest you to place the panels which are to be drilled on a sacrifice board. Also, make sure that the hole stays clean on both sides. Superior cutting performance in drilling are helicoidally drills with a drill point angled at 60° to 80° (instead of 120° for conventional metal drills) and with steep chip evacuation (so-called rapid inclination) and a wide channel.
- To ward off any possibility of chipping, we recommend you to place the panels which are to be drilled on a sacrifice board. You can use hole saws for large diameters.

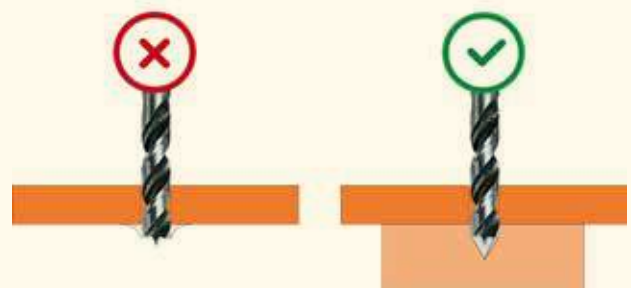

## CNC - PERFORATION

- Depending on the application, panel thickness above 6 mm could be used.
- Perforation could weaken the panels, and with limited thickness, they might become even weaker.
- Please ensure that more than 40% of the panel is not removed.
- The minimum space between two CNC's perforations should be 30 mm. This space must be provided from outer core to CNC's design equal to the opening or diameter of the perforation. The same also applies to edge distances.
- Always use a maximum length equal to the span distance "X" between fixing points minus 10% for grooves. In other words, the maximum length of the grooves should be equal to 0.9X.
- The wideness of the groove should not be more than 3 times the panel's thickness.
- Make sure that the distance between the grooves is equal to 5 times the panel's thickness.
- Make sure that the distance between the grooves in their prolongation is equal to 10 times the thickness of the panel.
- Make sure that the distance between the 1st groove and the parallel edge of the panel is equal to 10 times the panel thickness.
- We suggest you to execute a mock-up in order to check the stiffness and strength of the panel with the fixation.
- Please ensure that you always follow the local regulations with respect to openings in cladding, especially to wind loads, fire regulation and children safety.

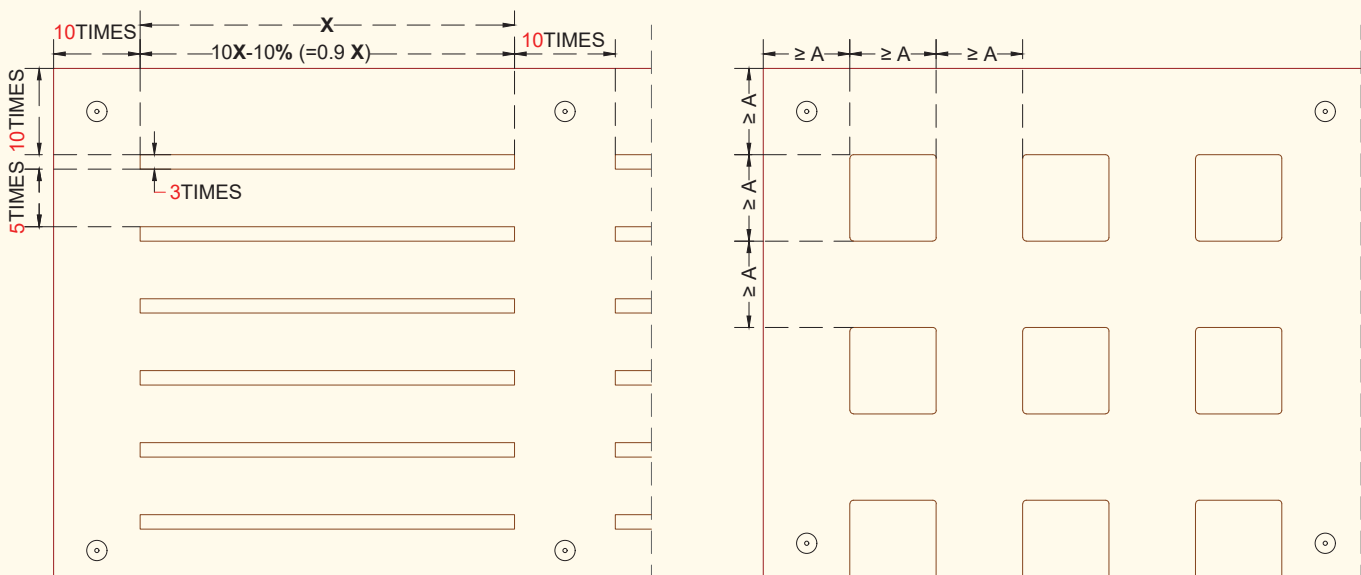

## FIXED AND LOOSE POINTS

- In Merino Armour EWC, the diameter of the drill hole must be drilled larger than the diameter of the Rivet fastening.
- This depends greatly on the required expansion clearance.
- This is equivalent to the shaft diameter of the fastening plus 2 mm for every meter of Armour Cladding starting from the fixed point.
- The head of the Rivet fastening must be big enough so that the drill hole in Merino Armour EWC is always covered.
- The rivet fastening must be placed in a manner that the cladding panel can move.
- The rivets must be put in place with flexible mouth-pieces.
- The clearance set for the rivet head must allow movement of the elements in the drill hole.
- Clearance 0.3 mm or 0.4 fixings must not be over-tightened.
- If need be, please avoid using any countersunk screws.
- The centre point of the drill hole in the Sub-Frame must coincide with the centre point of the drill hole in Merino Armour EWC cladding panel.
- The fastenings should be put in place starting from the middle of panel outwards.

## FIXED POINTS

- These are used for uniform distribution (halving) of the expansion and shrinkage movements.
- The diameter of the drill hole in the Merino Armour panels is the same dimensions as the diameter of the fastening.

## LOOSE POINT

- The loose point is in addition to the fixed point will be able to hold the weight of the panel.
- It should be placed in the same level. Expansion and shrinking are not constrained.

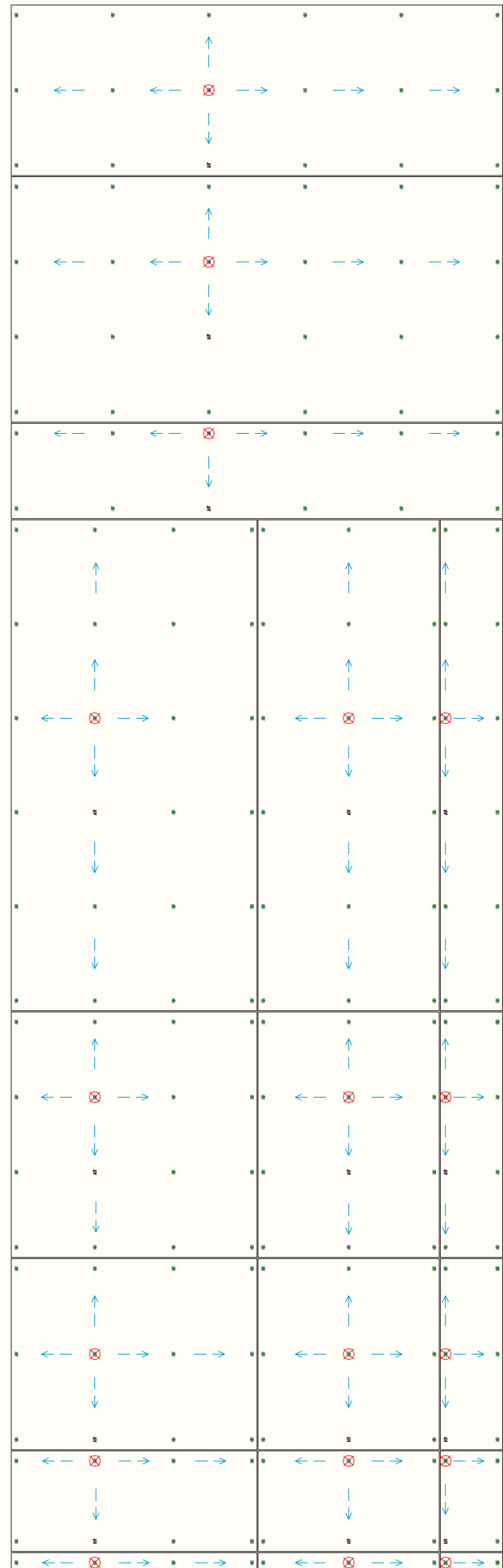

## GENERAL MEASURES

When it comes to building guidelines, obligations and legislations, if any, it is presumed that local and national building codes are known to the client.

Please ensure that these guidelines and legislations are implemented exactly as they are written here.

In case, the local or national guidelines conflicts with processing guidelines as provided in the manual. Kindly consult Merino technical representative.

## PRINCIPLE – VENTILATED FAÇADE

Between the bearing structure insulated on the outside and the panel secured to it, a naturally ventilated cavity is created.

A well-realized ventilated facade has the following benefits:

- Infiltrating rainwater (with open joints) is allowed to drain away and condensation is allowed to dry by the ventilated cavity.
- This is beneficial for a long-term qualitative insulation that doesn't get wet.
- A joint profile stops rainwater infiltration and hence minimizes the amount of moisture behind the panel.
- Application of a joint profile (e.g. aluminium L&T profile) helps give the facade a neatly finished appearance.
- This supports in moderating moisture and temperature fluctuations.
- The thickness of the thermal insulation is to be adapted as per local needs and regulations. The differential temperature and pressure of bottom and top of the building causes a natural air flow (chimney effect) behind panel.
- Helps to moderate, moisture from the construction and condensation from the use of the building through the ventilated gap behind the panels.
- The external insulation of bearing construction stabilizes any structural setting of the building, which allow, low temperature variations at the inside of the building. This also minimizes the risk of cold bridges.

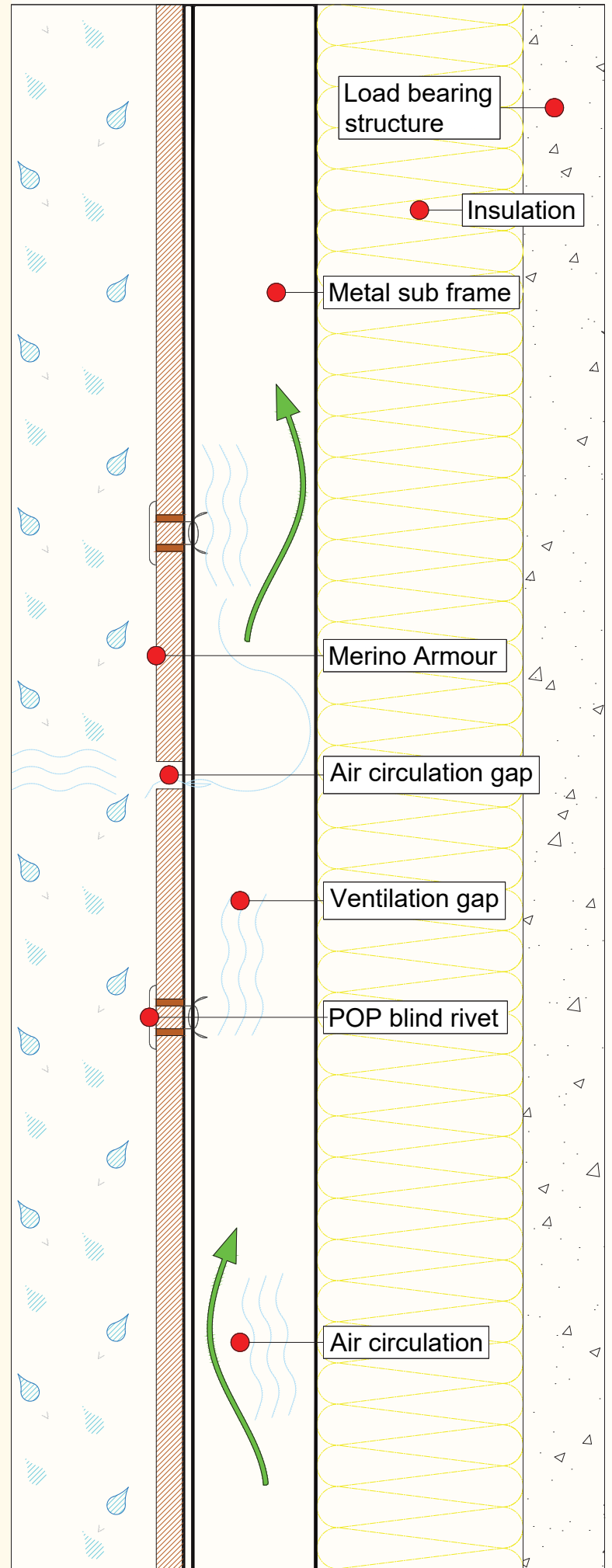

- Due to the composition of the facade in different layers the noise frequencies are reduced on different levels and providing functionality to isolate undesirable noises. It is even possible to improve this advantage by adding specific sound reduction isolation layer.
- Moreover, it could function as a lightning arrester. As in a ventilated facade it is easy to have an improved fire safe cladding by using fire resistant materials for the insulation, sub construction and cladding. Please note that it is also important to place stainless steel fire partitions between the storey levels in order to prevent the fire propagation through the ventilation cavity.
- For naturally ventilated cavity, following should be considered.
- Important air inlet openings at the bottom of the cladding and sufficient air outlet openings at the top of the cladding.
- Please note that it is also important to provide them at window sills and at window and door lintels.
- Minimum 50 cm<sup>2</sup> /m for facade parts 3 m height (uninterrupted opening of 5 mm) and minimum 100 cm<sup>2</sup> /m for facade parts 3 m height (uninterrupted opening of 10 mm).
- The size of the air inlet and outlet openings should be proportioned according to the height of the cavity to be ventilated with a maximum opening equal to the depth of the cavity.
- A cavity should be at least 20 cm wide and minimum 2.5 cm deep.
- The continuity of open-air circulation in the cavity.
- Masking of ventilation openings with perforated screens and or perforated profile of openings 1 cm, in order to stop vermin and insects accessing the rear of the cladding.
- At the same time be careful to respect the minimum % of opening required through the perforated openings of the screens.
- It is of utmost importance to have the sub construction orientated perpendicularly to the façade cladding for horizontal Armour panel application. This allows for natural airflow.

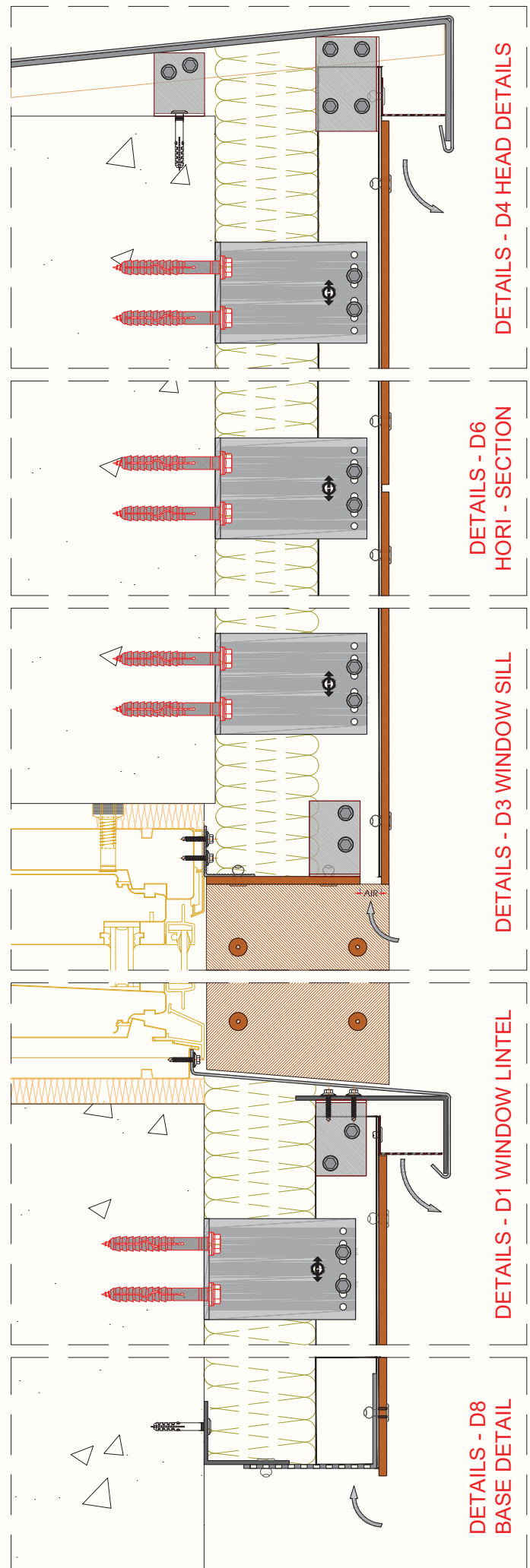

- In order to maintain ventilation between the "warm" side of the building and the "cold" exterior, it is important to reduce the distance between the bearing sub-construction.

**MERINO** ARMOUR EXTERNAL WALL CLADDING  
HORIZONTAL SECTION FIXING DETAILED VIEW

A - CLADDING TERMINATION DETAILS	
SL/NO	CONTENT
1	EXISTING CONSTRUCTION
2	INSULATION
3	ANCHOR FASTENER
4	ADJUSTABLE L BRACKET
5	SELF TAPPING SCREW
6	VERTICAL L PROFILE
7	<b>MERINO</b> ARMOUR EWC
8	<b>MERINO</b> POP BLIND RIVET
9	L PROFILE

B - EXTERNAL CORNER DETAILS	
SL/NO	CONTENT
1	EXISTING CONSTRUCTION
2	INSULATION
3	ADJUSTABLE L BRACKET
4	ANCHOR FASTENER
5	SELF TAPPING SCREW
6	VERTICAL L PROFILE
7	<b>MERINO</b> ARMOUR EWC
8	<b>MERINO</b> POP BLIND RIVET
9	L PROFILE

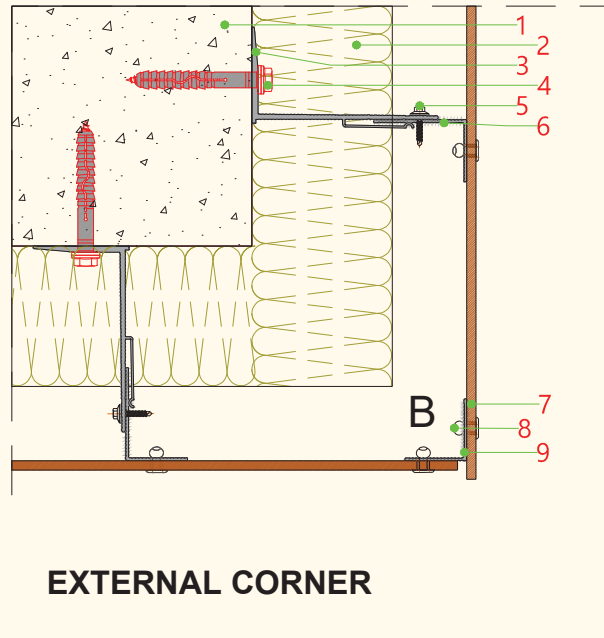
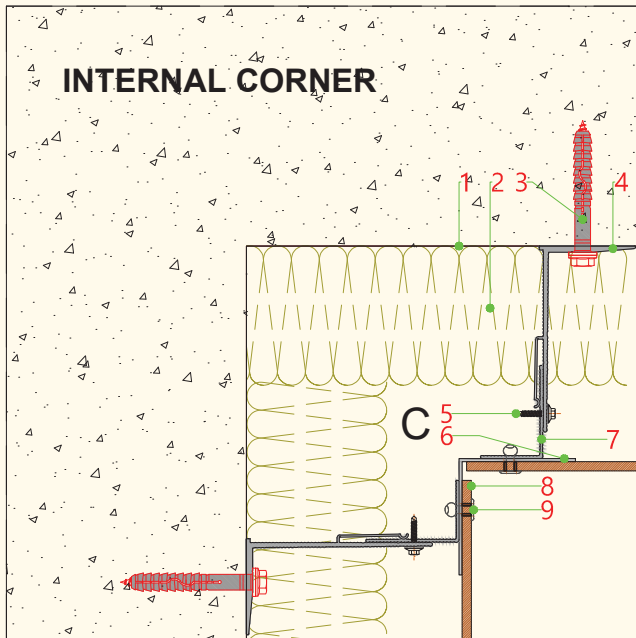
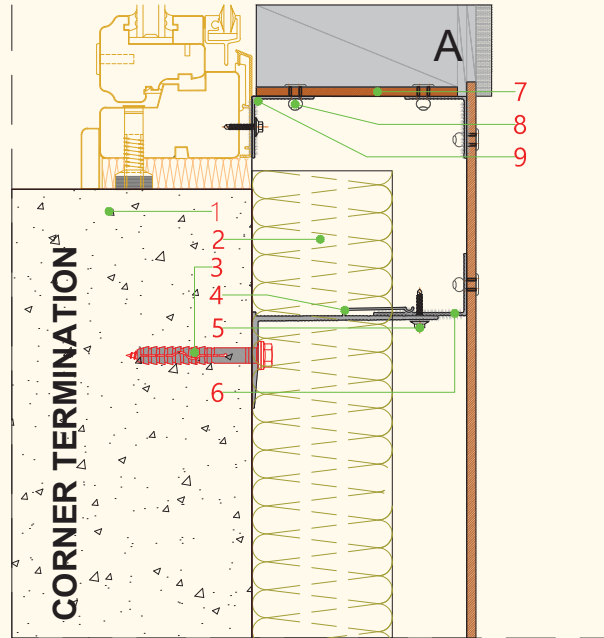

**EXTERNAL CORNER**

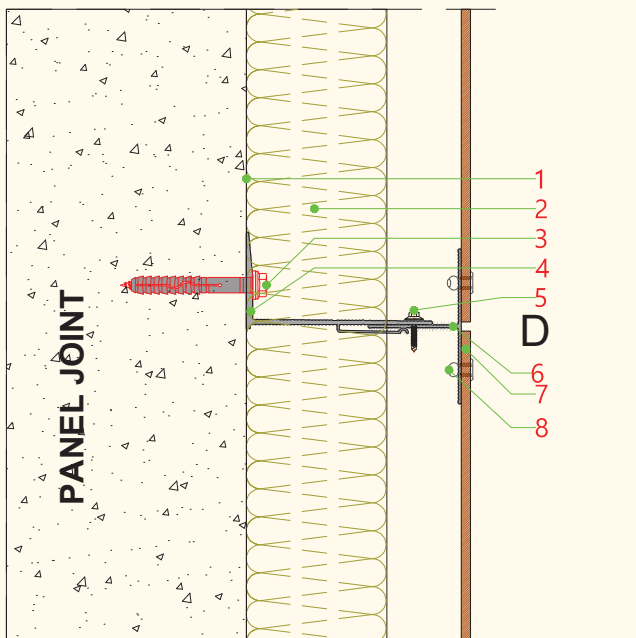

C - INTERNAL CORNER DETAILS	
SL/NO	CONTENT
1	EXISTING CONSTRUCTION
2	INSULATION
3	ANCHOR FASTENER
4	ADJUSTABLE L BRACKET
5	SELF TAPPING SCREW
6	VERTICAL L PROFILE
7	<b>MERINO</b> ARMOUR EWC
8	<b>MERINO</b> POP BLIND RIVET
9	L PROFILE

D - PANEL JOINT DETAILS	
SL/NO	CONTENT
1	EXISTING CONSTRUCTION
2	INSULATION
3	ADJUSTABLE L BRACKET
4	ANCHOR FASTENER
5	SELF TAPPING SCREW
6	VERTICAL L PROFILE
7	<b>MERINO</b> ARMOUR EWC
8	<b>MERINO</b> POP BLIND RIVET



## CHARACTERISTICS AND JOINTS

Panel shrinks when it loses moisture and expands when it absorbs, as temperature and humidity affect the panel dimensions. Dimensional changes must be well thought of while working with panels.

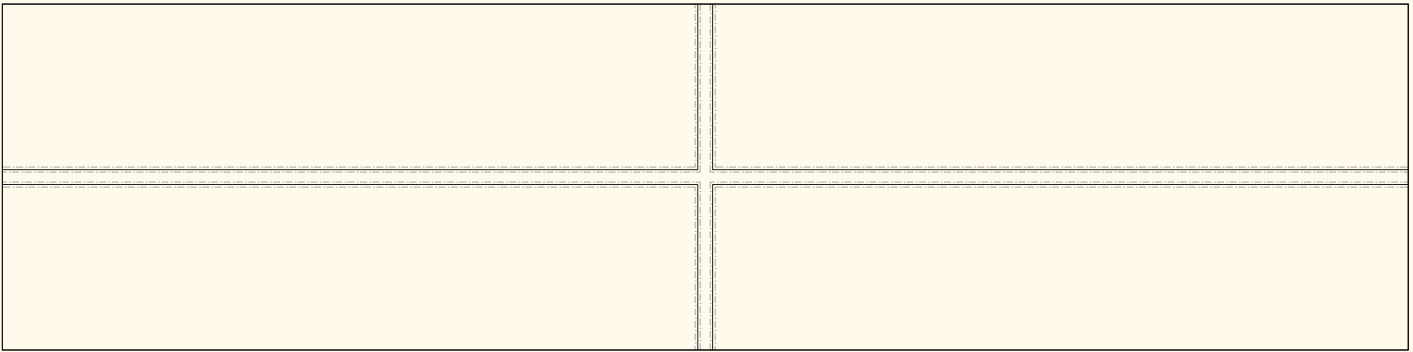

- The panel dimensions is affected by temperature and humidity. Please take this into account while evaluating the joint width between panels. Usually, a dilatation gap should be calculated as 0.15% of the length of the panel for the longitudinal direction and 0.3% of the width for the transversal direction
- A minimum gap of 6 mm is required. This acts not only as a technical but also an aesthetical function. Smaller the joints, more joint width differences will be visible.
- In cases where a profile (aluminium or plastic) is placed in the joint, spacing should be allowed on both sides of the profile equal to half the joint width.
- For aesthetic considerations, it is uniform to mask the joints, but also necessary in order to prevent insects and vermin nesting behind the panels.
- An open joint facade cladding is less subject to wind suction effect on the panels.
- Any amount of potential rain or damp infiltration at open joints can badly affect the insulation. Placing a vapor permeable moisture barrier can be a solution for this.
- Please note that in order to stop access to vermin and insects behind the cladding, the openings must be closed off in the places where air supply and extraction needs to be provided, with specially designed perforated screens and or perforated profiles.

**NOTE:** Sealants are not recommended in expansion joints as this may lead to panel stressing and may result in panel deformation.

**Expansion clearance can be calculated as below:**

$$\text{Expansion Clearance} = \frac{\text{Length or Width (mm)}}{500}$$



## FIXING PLAN

- For the stability of the panel, the fastening spacing indicated in the tables here under are indicative. They do not take into account wind loads, specific regional regulations, geographical location of building and physical location of the panel on the facade.
- The amount of spacing mentioned above has not taken into account the type of the bearing construction on which the subconstruction is fixed (or the type of the sub-construction itself).
- We strongly suggest that the spacing distances must be as per a structural engineering calculation. It must also take into account all the above-mentioned factors.
- For glued applications the spacing measurements should be ideally reduced by 20%.
- For horizontal or inclined applications the spacing measurements should be reduced by 20%.
- These measurements should be reduced by an additional 20%, in case the horizontal or inclined applications are glued. All in all, this will amount to a total of minus 36% on the values indicated below.

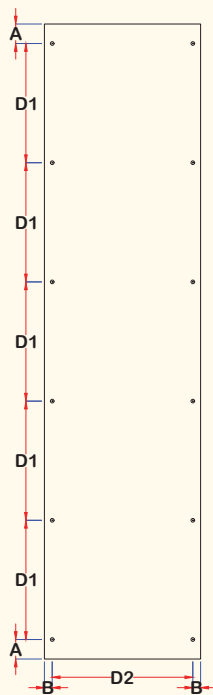

**SINGLE SPAN**

THICKNESS MM	MAX D1- MM	MAX D2 - MM	A - MM	B - MM
6	600	450	20-40	20-40
8	750	600	20-60	20-60
10	900	750	20-80	20-80
12	1050	900	20-100	20-100

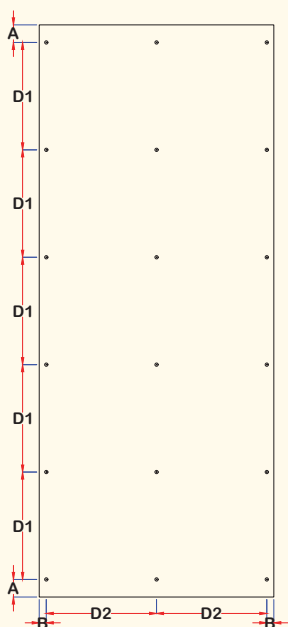
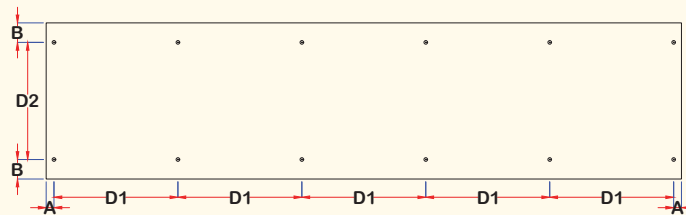

**DOUBLE SPAN**

THICKNESS MM	MAX D1- MM	MAX D2 - MM	A - MM	B - MM
6	600	500	20-40	20-40
8	750	650	20-60	20-60
10	900	800	20-80	20-80
12	1050	950	20-100	20-100

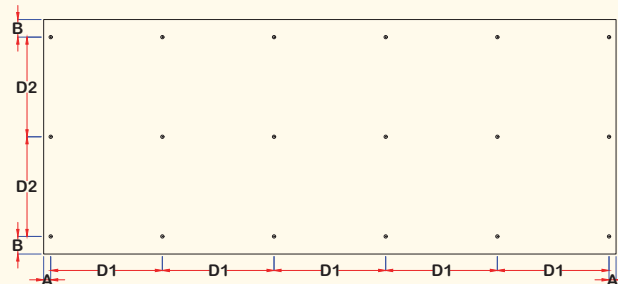

## CURVE USING FLAT ARMOUR PANELS

In order to allow the panel to follow the radius of a curved surface and maintain its position once fastened, Merino Armour EWC also has a host of bending properties. The specifications on the table below must be followed, in order to ensure the panel's performance and proper installation.

The panels for curved facades are only fastened using the exposed fastening system with rivets.

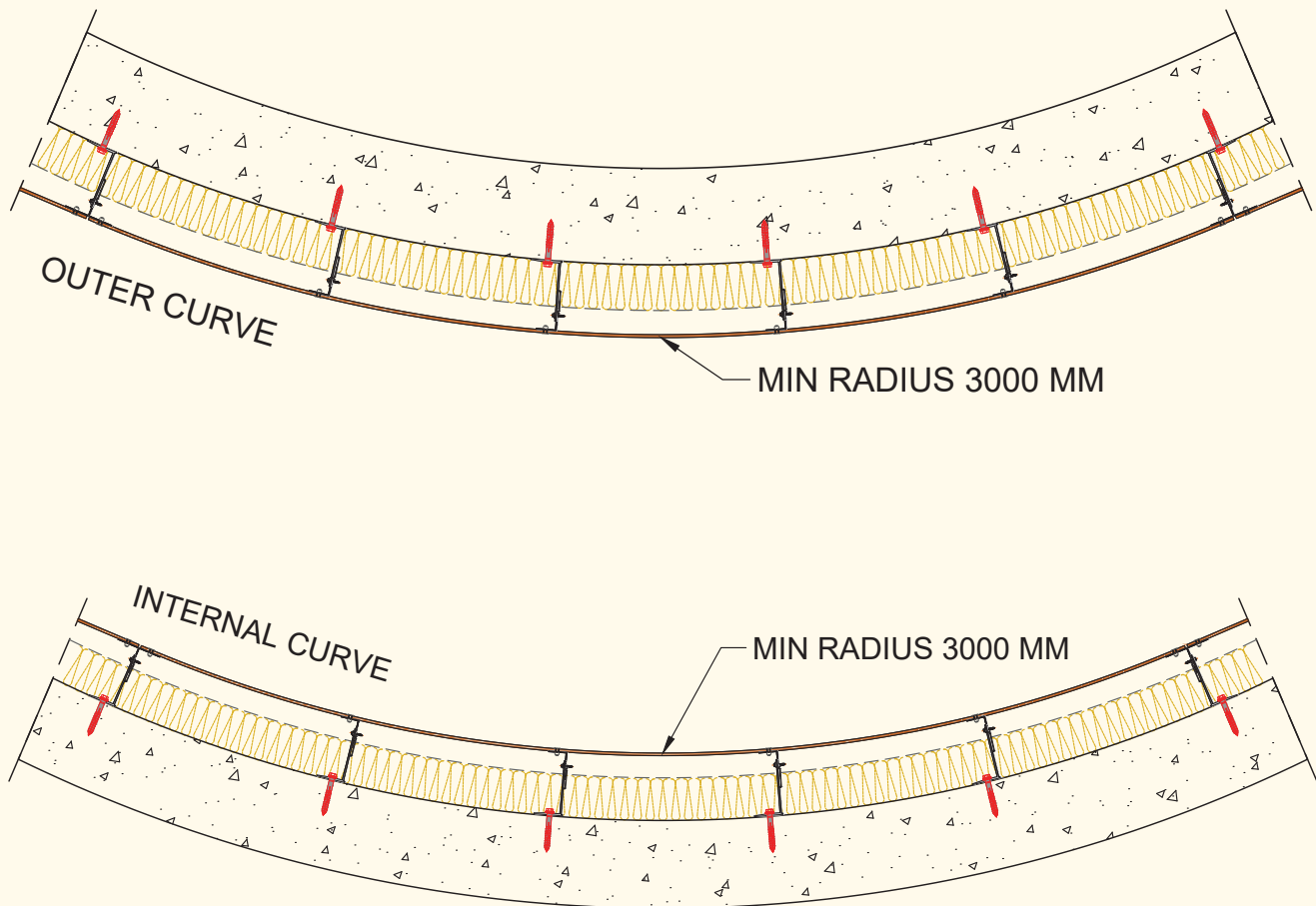

## CORNERS

Please note that the corners could either be open or closed. If the corners are closed without any possibility of the joint opening and closing, the panel dimensions on either side of the corner may not exceed 300 mm. If they do exceed 300 mm, the corner must be considered as fixed and the following dilatation gap should be twice the calculated width.

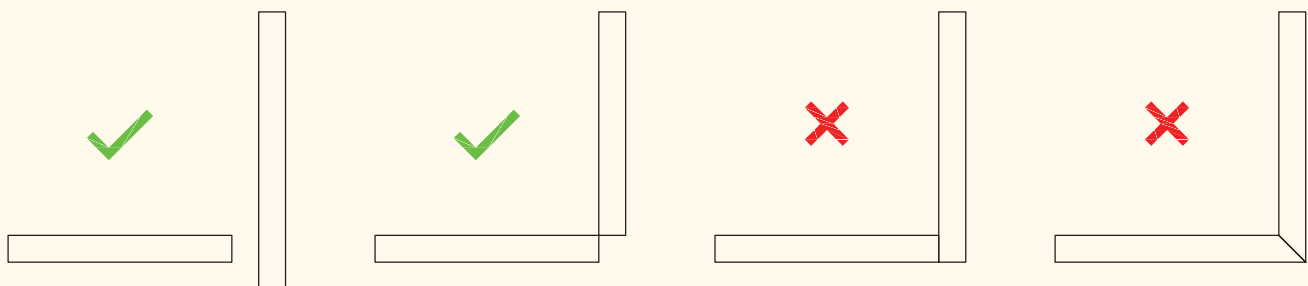

## FIXING SYSTEMS GENERAL GUIDELINES

Important points to be kept in mind while using and dimensioning Merino Armour EWC Panels:

- The armour panels must be mounted to be freely suspended. They are also self-supporting. Under such a condition, they remain ventilated along the front and rear faces. (e.g. not fastened onto a solid carrier or on a full background).
- It is important to view the strength and stiffness of the panels as a function of the thickness of the panel. This is aligned with the planned backing structure and type of fixing.
- The panels should not be given any structural or stabilizing applications.
- In case there are any heavy elements that are to be suspended from the panels, it is advisable to fasten them to the underlying structure.
- Armour panels should always be applied with free ventilation.
- Expansion joints should always be allowed between the panels themselves and between the panels and any potential obstructions.
- A minimum gap of 6 mm is required. A joint of 10 mm is always covering all possible dimension changes within a panel, taking in account normal atmospheric variations.

**Note:** The free expansion contraction of the panels must be respected by providing enough clearance around the fixings.

## TYPES OF STRUCTURES AND FIXINGS

Below are a few critical points which should be kept in mind. These points are common to all kinds of sub-construction:

- On-site tests could be realized with the supplier of the anchors or of the sub-construction. Fixing points to the bearing structure of the building should have at least a pull-out strength of min 3KN.
- For anchoring a sub-construction, it is recommended to refer in the directives of the supplier.
- A subconstruction, in whatever material is used, should never have a flatness tolerance larger than L 1000 over the whole surface of the facade and should never exceed 2 mm between the fixing points of the panels.
- Dilatation of the material used as sub-construction especially at linear prolongations should always be kept in mind. In most cases, a dilatation gap will be necessary.
- Dilatation gaps of the Merino Armour EWC panels and the sub-construction should always tally with each other.

**DESIGN PATTERNS**

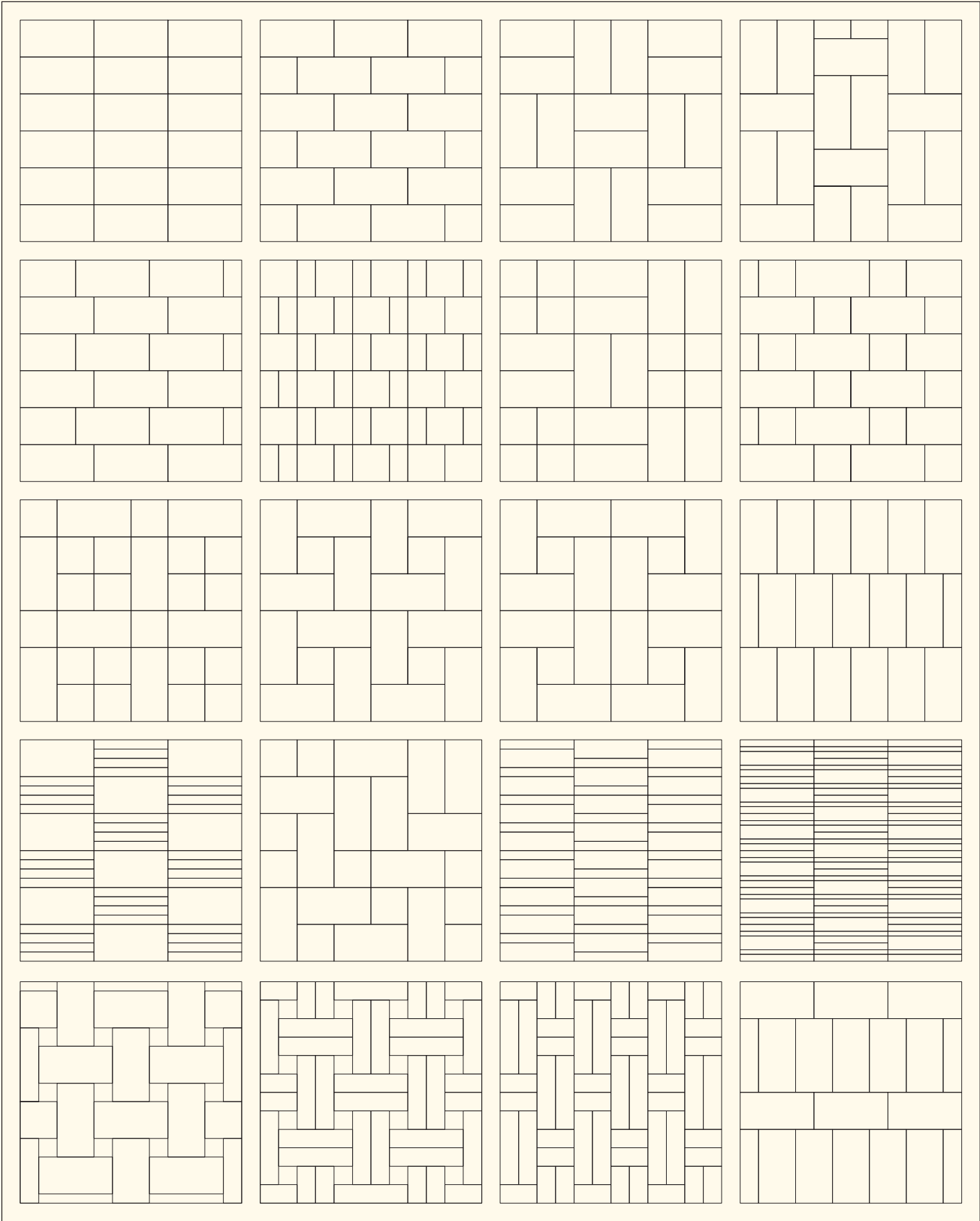

# MAIN GATES AND RAILINGS

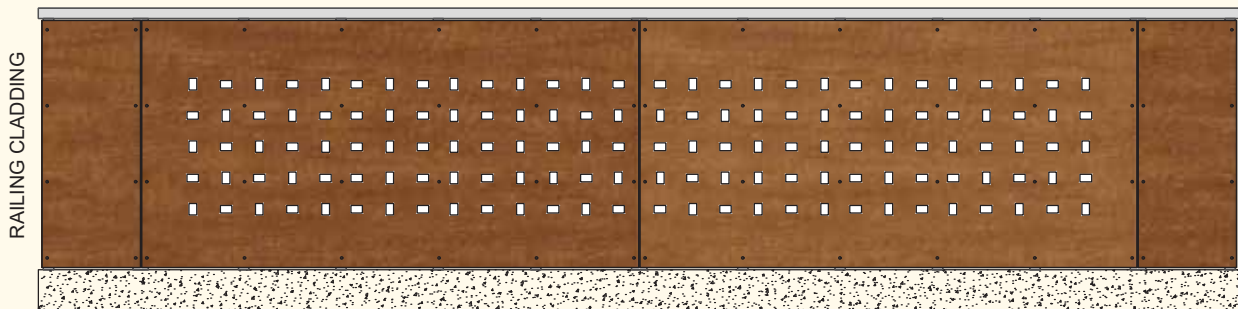
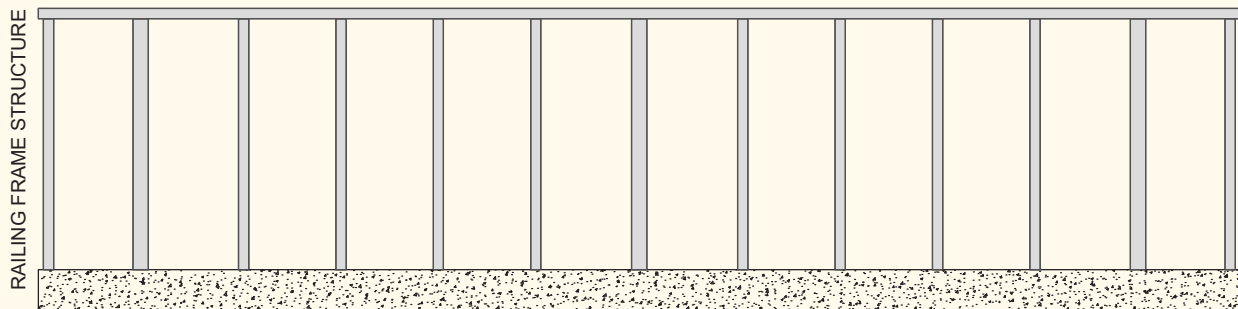
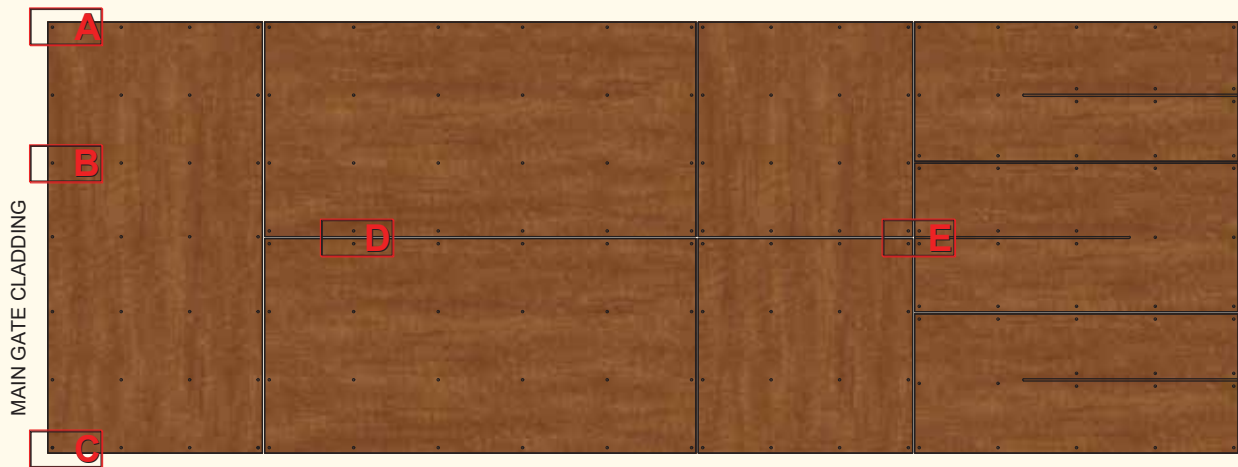
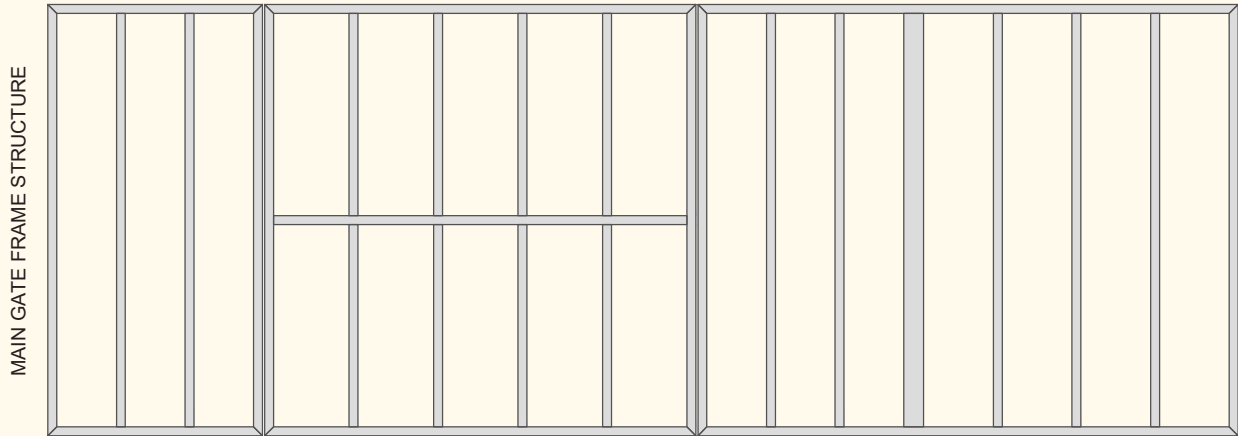
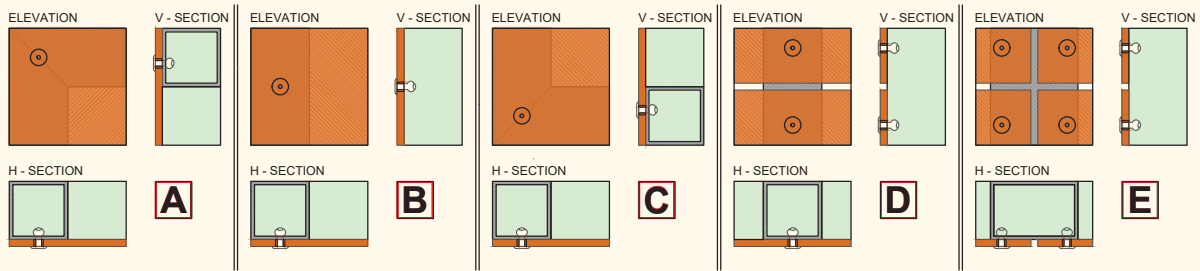

# TYPE OF STRUCTURES AND VARIOUS SYSTEMS



## Visible fixing systems...

1. 'BOX Profile' system
2. 'L-T Profile' system
3. 'J & U Profile' system



## Concealed fixing systems...

1. 'Adhesive' system
2. 'Z - Profile' system
3. 'J Profile' system
4. 'Undercut' system

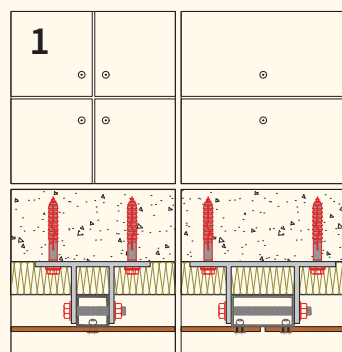

1. 'BOX Profile' system

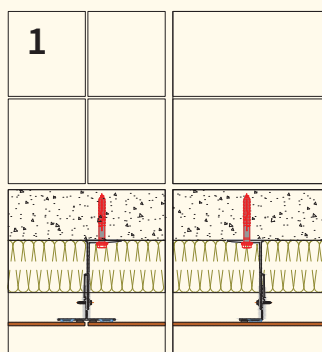

1. 'Adhesive' system

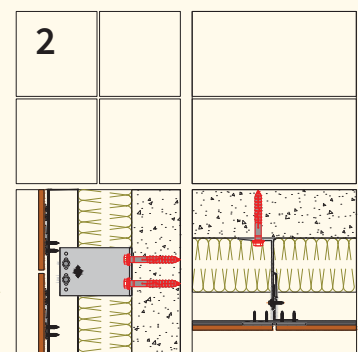

2. 'Z - Profile' system

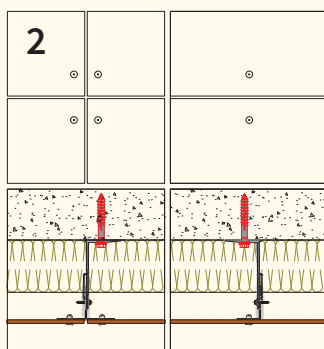

2. 'L-T Profile' system

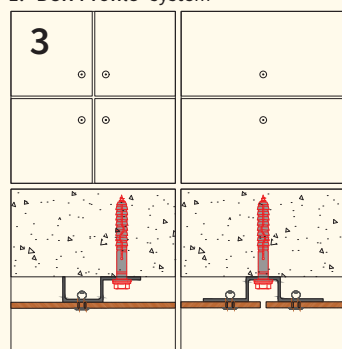

3. 'J & U Profile' system

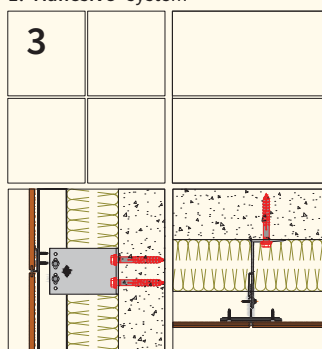

3. 'J Profile' system

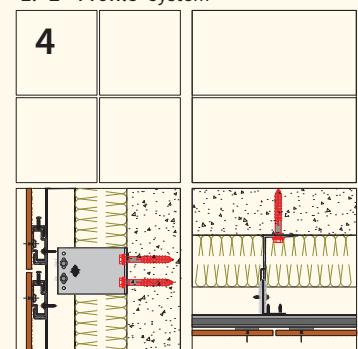

4. 'Undercut' system

**VISIBLE FIXING. 1. RIVETED 'BOX' PROFILE SYSTEM.**

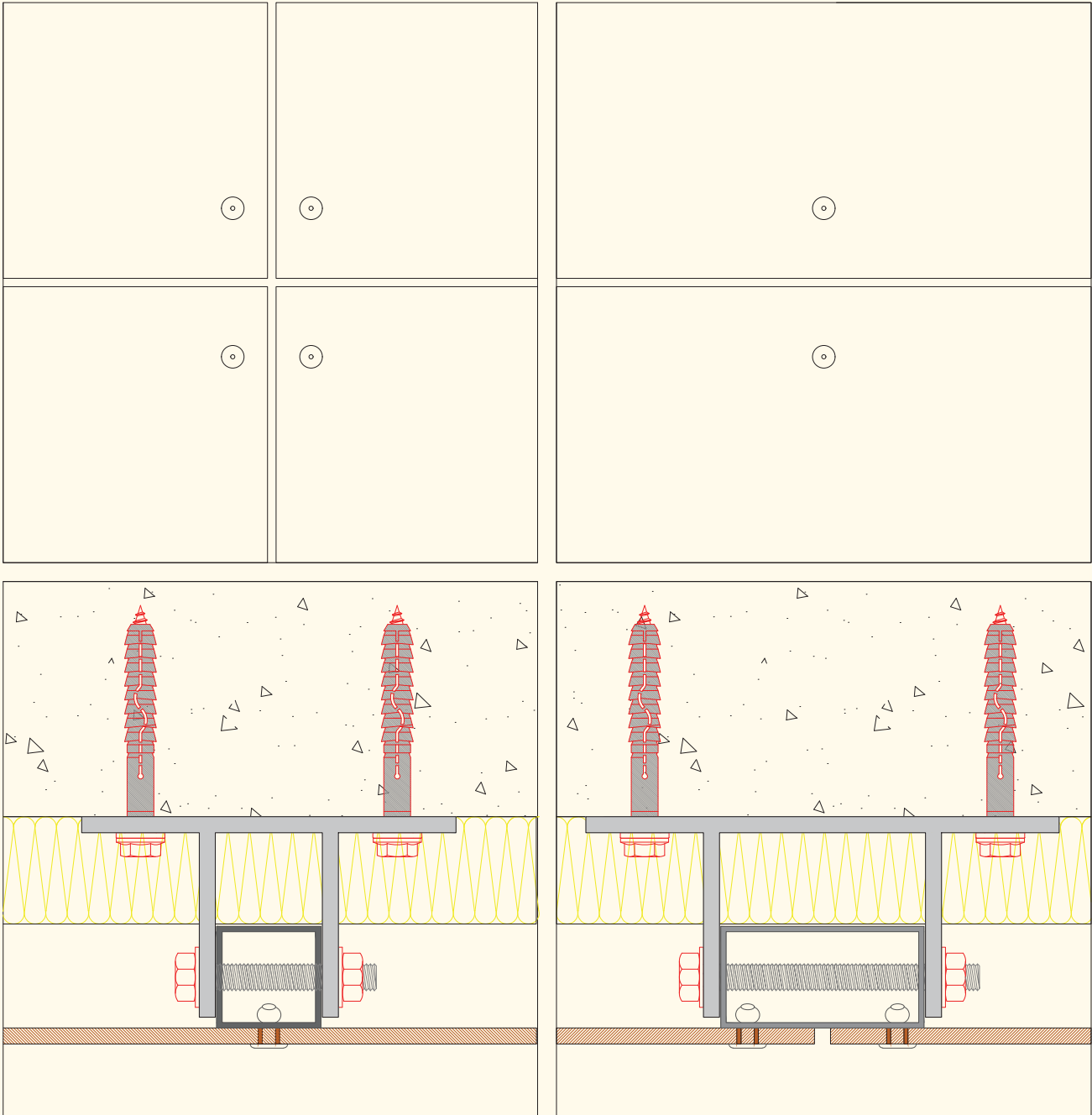



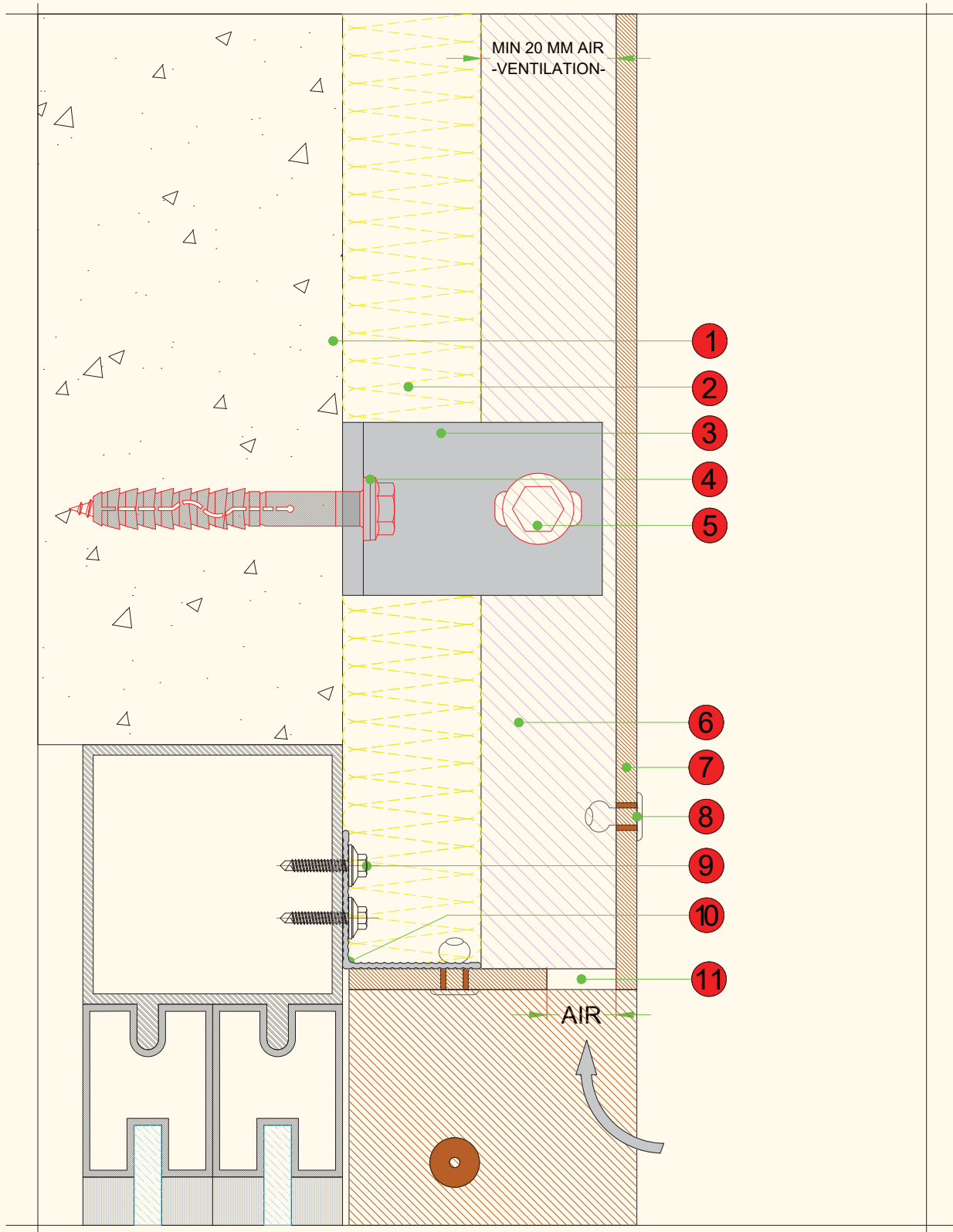

Sl. No.	Accessories	Riveted - Visible Fixing 'Box Profile' System	D1 - Window Lintel
1	EXISTING CONSTRUCTION		
2	INSULATION		
3	ADJUSTABLE U BRACKET		
4	ANCHOR FASTENER		
5	NUT BOLT WITH WASHER		
6	VERTICAL AL BOX PROFILE		
7	<b>MERINO</b> ARMOUR EWC		
8	<b>MERINO</b> POP BLIND RIVET		
9	SELF TAPPING SCREW		
10	L PROFILE		
11	AIR GAP FOR VENTILATION		

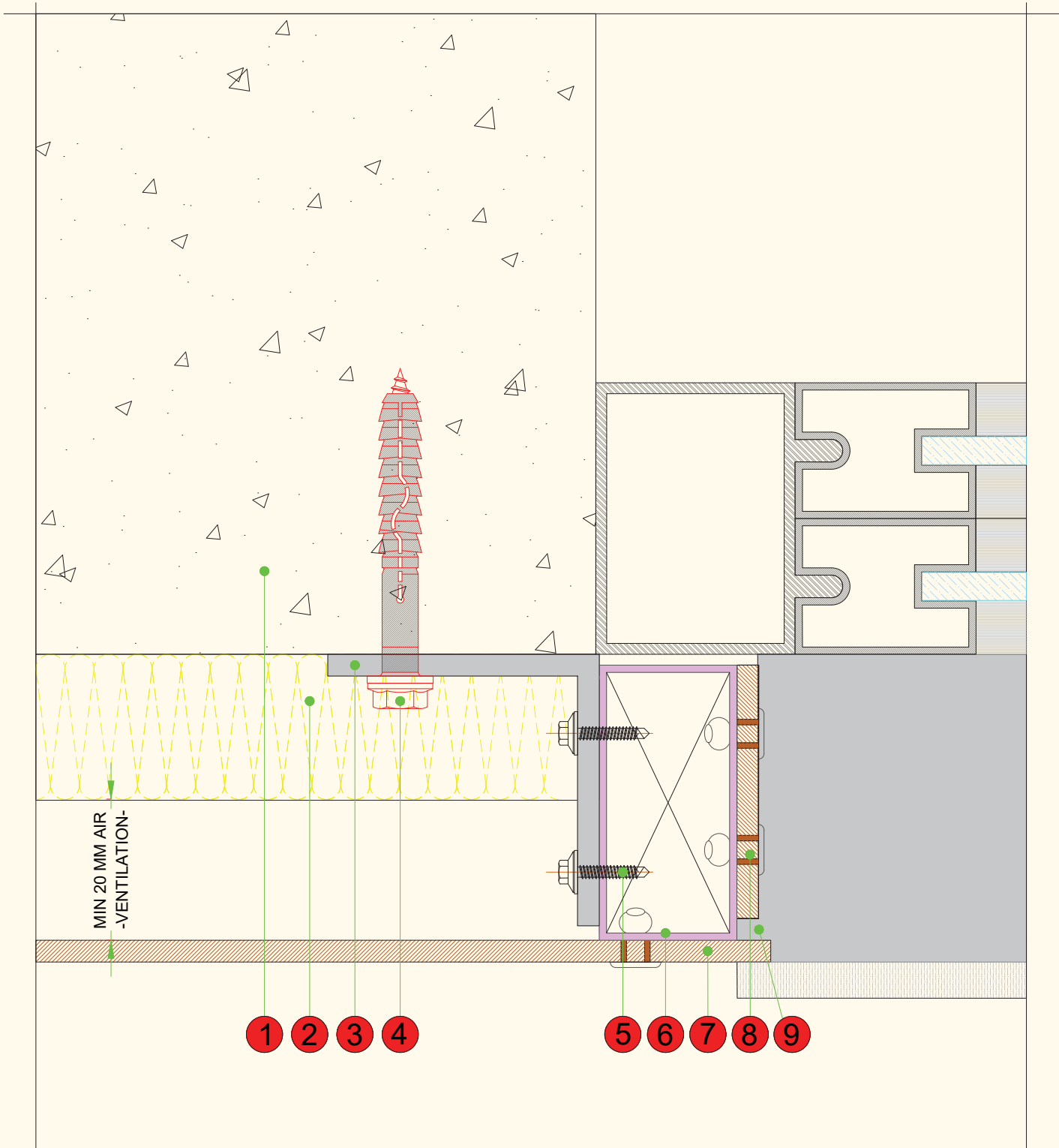

Sl. No.	Accessories	Riveted - Visible Fixing 'Box Profile' System	D2 - Window Reveal
1	EXISTING CONSTRUCTION		
2	INSULATION		
3	ADJUSTABLE L BRACKET		
4	ANCHOR FASTENER		
5	SELF TAPPING SCREW		
6	VERTICAL AL BOX PROFILE		
7	<b>MERINO</b> ARMOUR EWC		
8	<b>MERINO</b> POP BLIND RIVET		
9	GAP FOR AIR CIRCULATION		
10	FLASHING BY OTHERS		



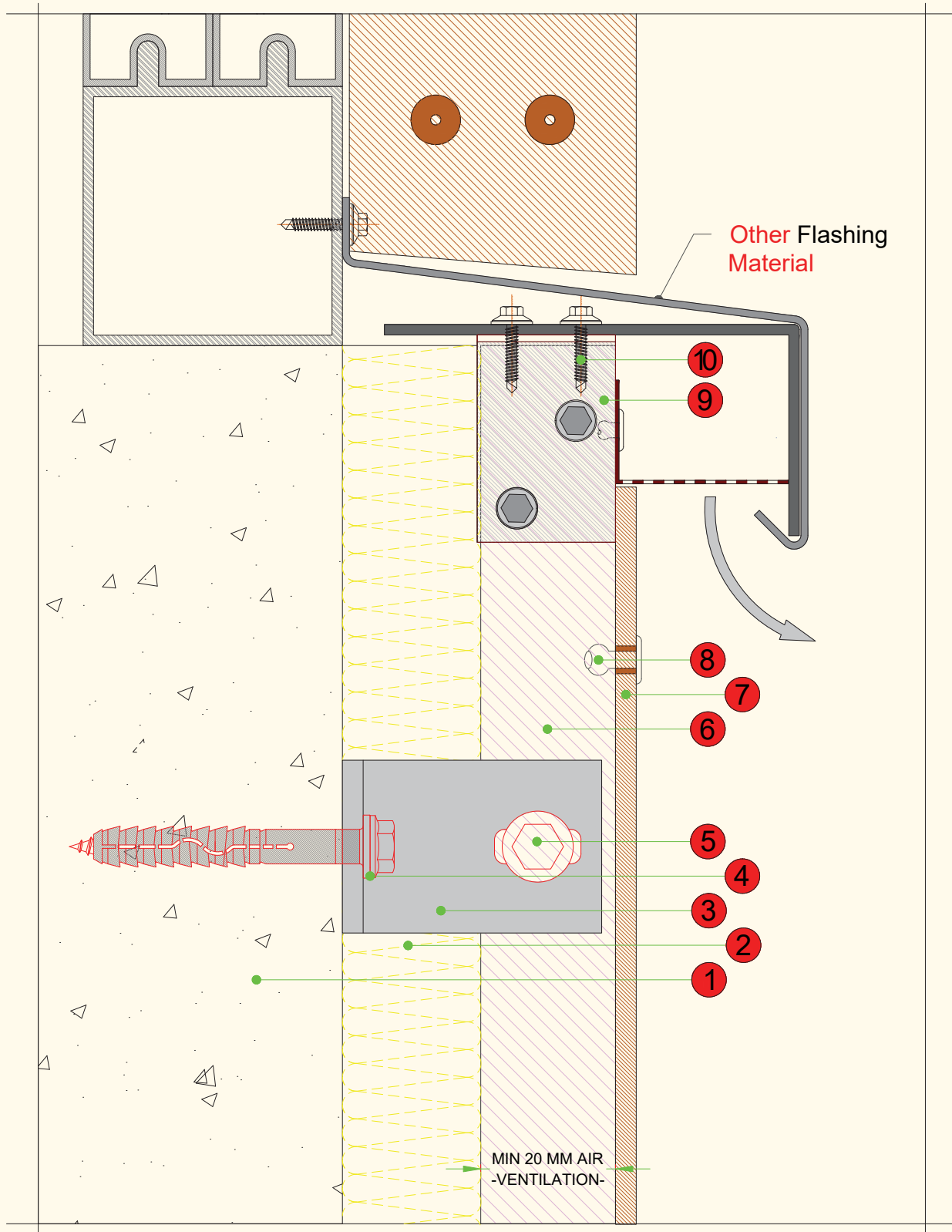

Sl. No.	Accessories	Riveted - Visible Fixing 'Box Profile' System	D3 - Window sill
1	EXISTING CONSTRUCTION		
2	INSULATION		
3	ADJUSTABLE U BRACKET		
4	ANCHOR FASTENER		
5	NUT BOLT WITH WASHER		
6	VERTICAL AL BOX PROFILE		
7	<b>MERINO</b> ARMOUR EWC		
8	<b>MERINO</b> POP BLIND RIVET		
9	L PROFILE		
10	SELF TAPPING SCREW		



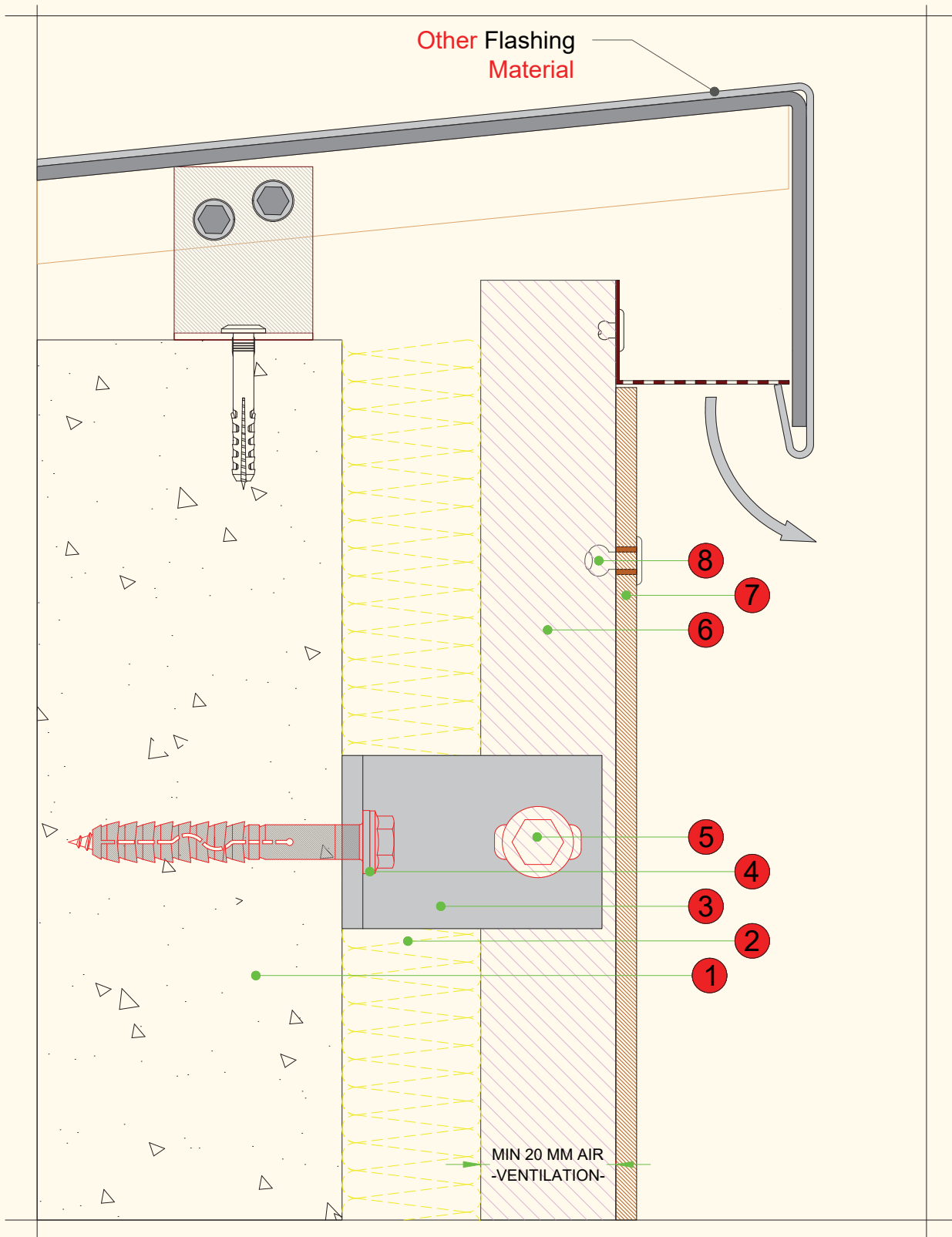

Sl. No.	Accessories	Riveted - Visible Fixing 'Box Profile' System	D4 - Head Details
1	EXISTING CONSTRUCTION		
2	INSULATION		
3	ADJUSTABLE U BRACKET		
4	ANCHOR FASTENER		
5	NUT BOLT WITH WASHER		
6	VERTICAL AL BOX PROFILE		
7	<b>MERINO</b> ARMOUR EWC		
8	<b>MERINO</b> POP BLIND RIVET		
9	L PROFILE		
10	SELF TAPPING SCREW		
11	FLASHING BY OTHERS		





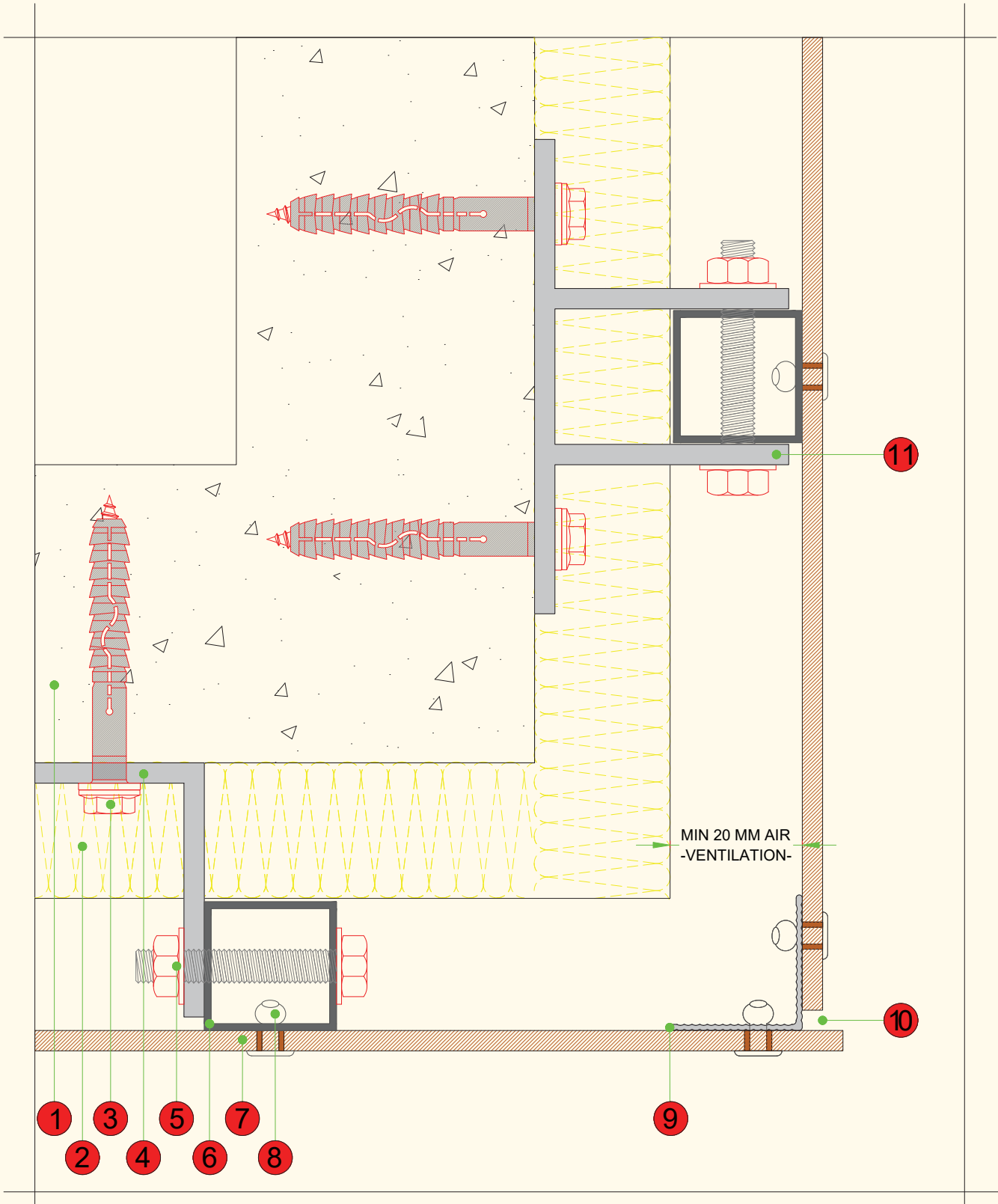

Sl. No.	Accessories	Riveted - Visible Fixing 'Box Profile' System	D5 - External Corner
1	EXISTING CONSTRUCTION		
2	INSULATION		
3	ANCHOR FASTENER		
4	ADJUSTABLE L BRACKET		
5	NUT BOLT WITH WASHER		
6	VERTICAL AL BOX PROFILE		
7	<b>MERINO</b> ARMOUR EWC		
8	<b>MERINO</b> POP BLIND RIVET		
9	L PROFILE		
10	GAP FOR AIR CIRCULATION		
11	ADJUSTABLE U BRACKET		



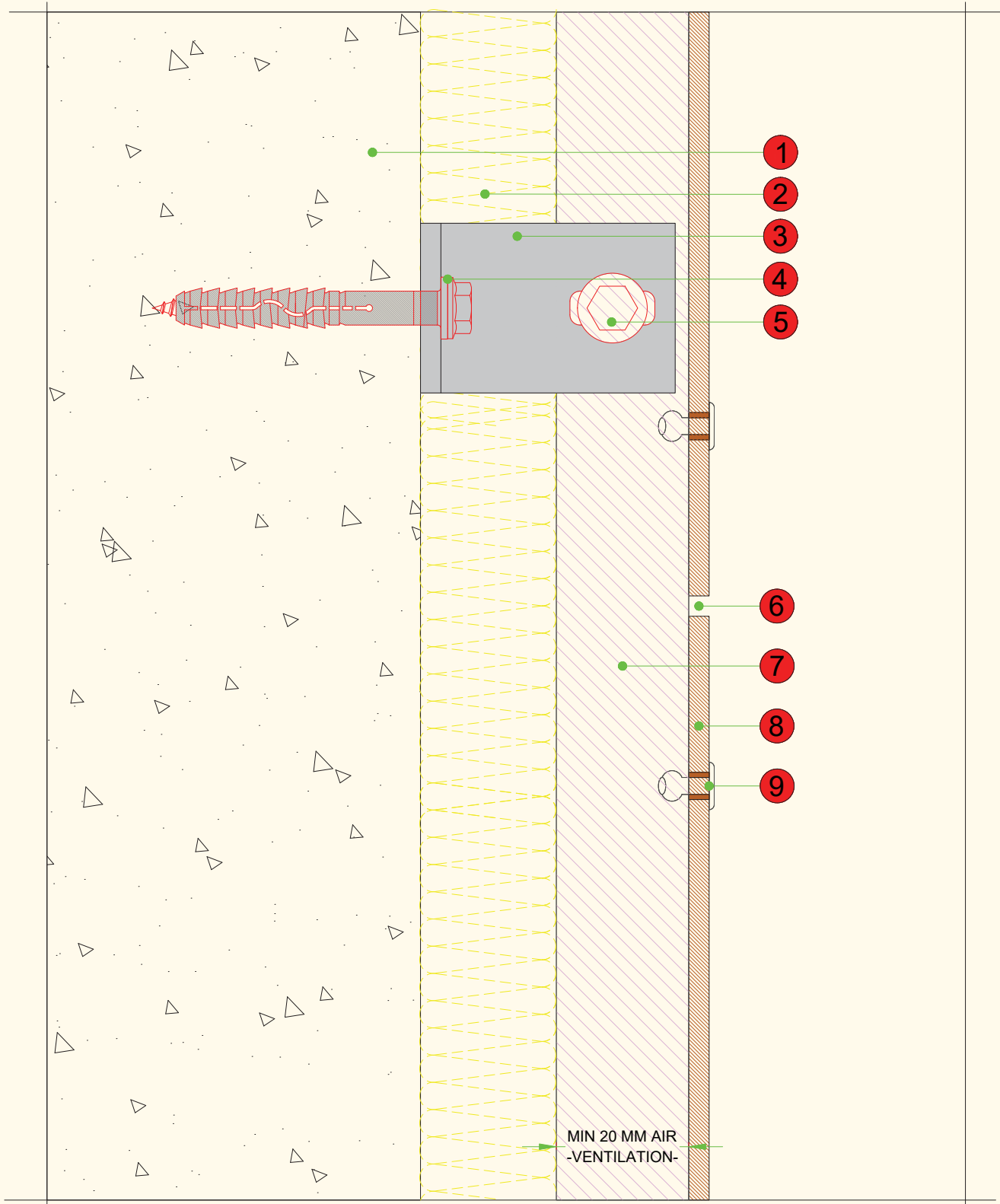

Sl. No.	Accessories	Riveted - Visible Fixing 'Box Profile' System	D6 - Vertical section
1	EXISTING CONSTRUCTION		
2	INSULATION		
3	ADJUSTABLE U BRACKET		
4	ANCHOR FASTENER		
5	NUT BOLT WITH WASHER		
6	AIR GAP FOR VENTILATION		
7	VERTICAL AL BOX PROFILE		
8	<b>MERINO</b> ARMOUR EWC		
9	<b>MERINO</b> POP BLIND RIVET		



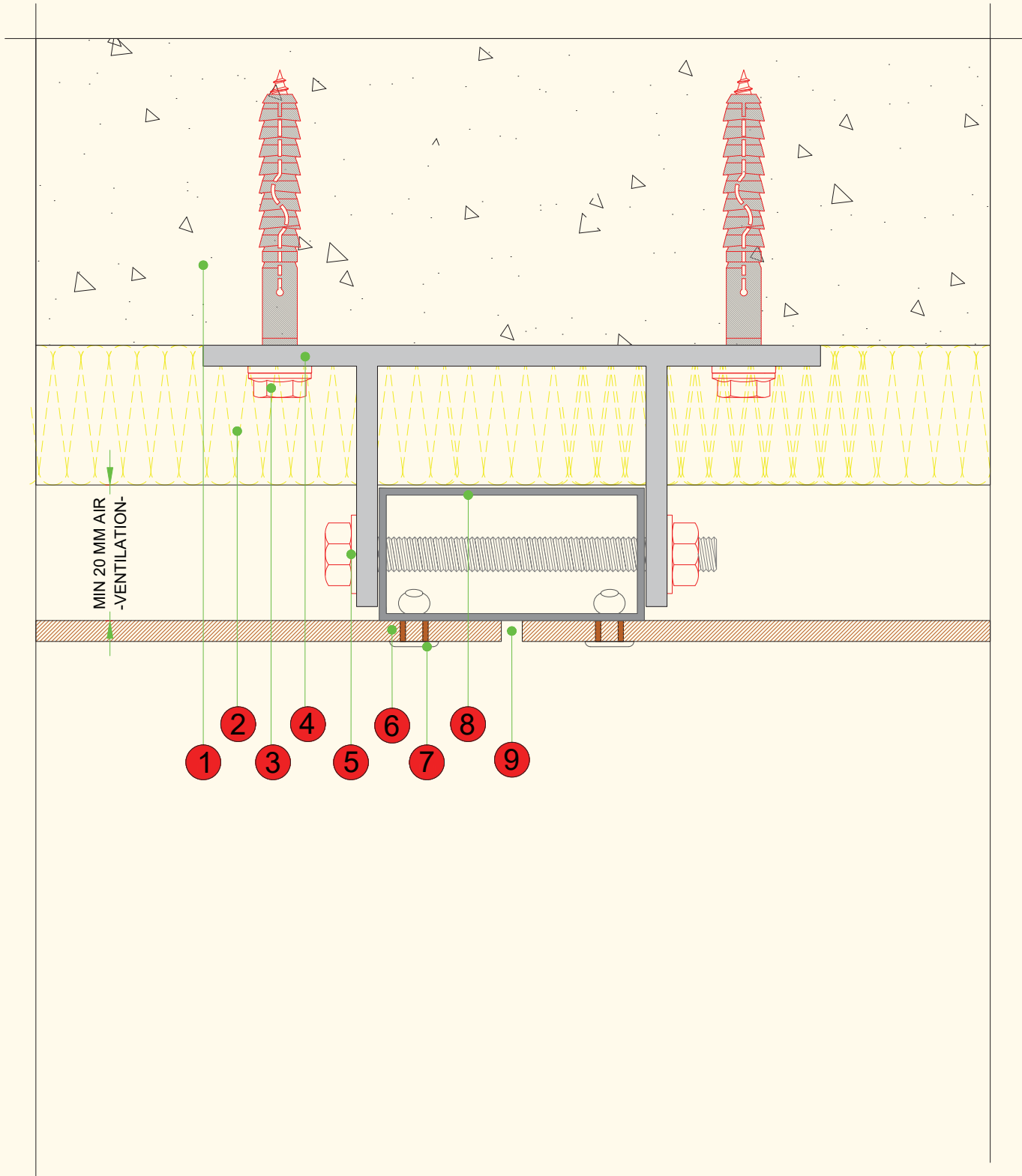

Sl. No.	Accessories	Riveted - Visible Fixing 'Box Profile' System	D7 - Horizontal section
1	EXISTING CONSTRUCTION		
2	INSULATION		
3	ANCHOR FASTENER		
4	ADJUSTABLE U BRACKET		
5	NUT BOLT WITH WASHER		
6	<b>MERINO</b> ARMOUR EWC		
7	<b>MERINO</b> POP BLIND RIVET		
8	VERTICAL AL BOX PROFILE		
9	GAP FOR AIR CIRCULATION		



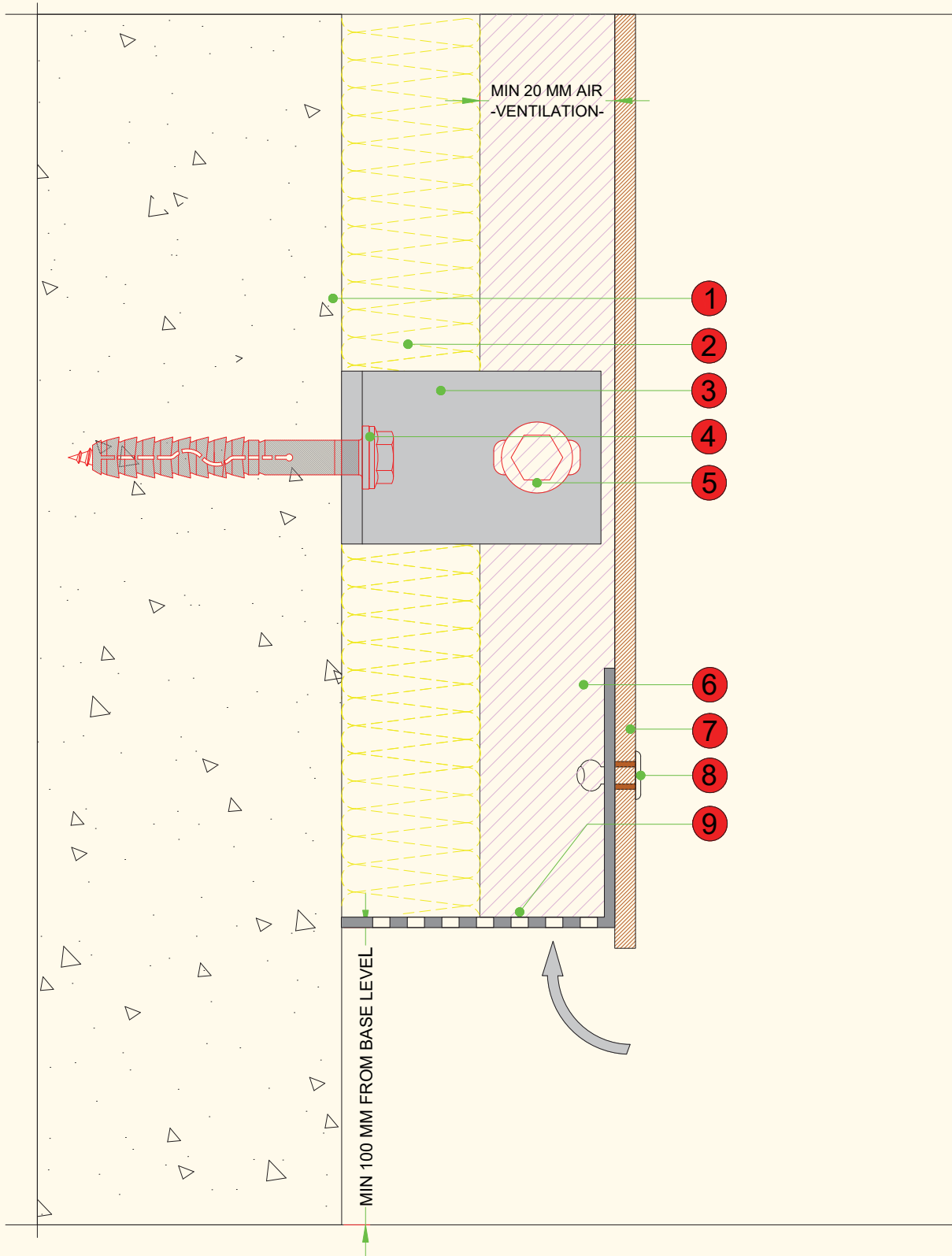

Sl. No.	Accessories	Riveted - Visible Fixing 'Box Profile' System	D8 - Base details
1	EXISTING CONSTRUCTION		
2	INSULATION		
3	ADJUSTABLE U BRACKET		
4	ANCHOR FASTENER		
5	NUT BOLT WITH WASHER		
6	VERTICAL AL BOX PROFILE		
7	<b>MERINO</b> ARMOUR EWC		
8	<b>MERINO</b> POP BLIND RIVET		
9	PERFORATED L RAIL		



Sl. No.	Accessories	Riveted - Visible Fixing 'Box Profile' System	D9 - Internal Corner
1	EXISTING CONSTRUCTION		
2	INSULATION		
3	ANCHOR FASTENER		
4	ADJUSTABLE L BRACKET		
5	NUT BOLT WITH WASHER		
6	VERTICAL AL BOX PROFILE		
7	<b>MERINO</b> ARMOUR EWC		
8	<b>MERINO</b> POP BLIND RIVET		
9	AIR GAP FOR VENTILATION		
10	ADJUSTABLE U BRACKET		

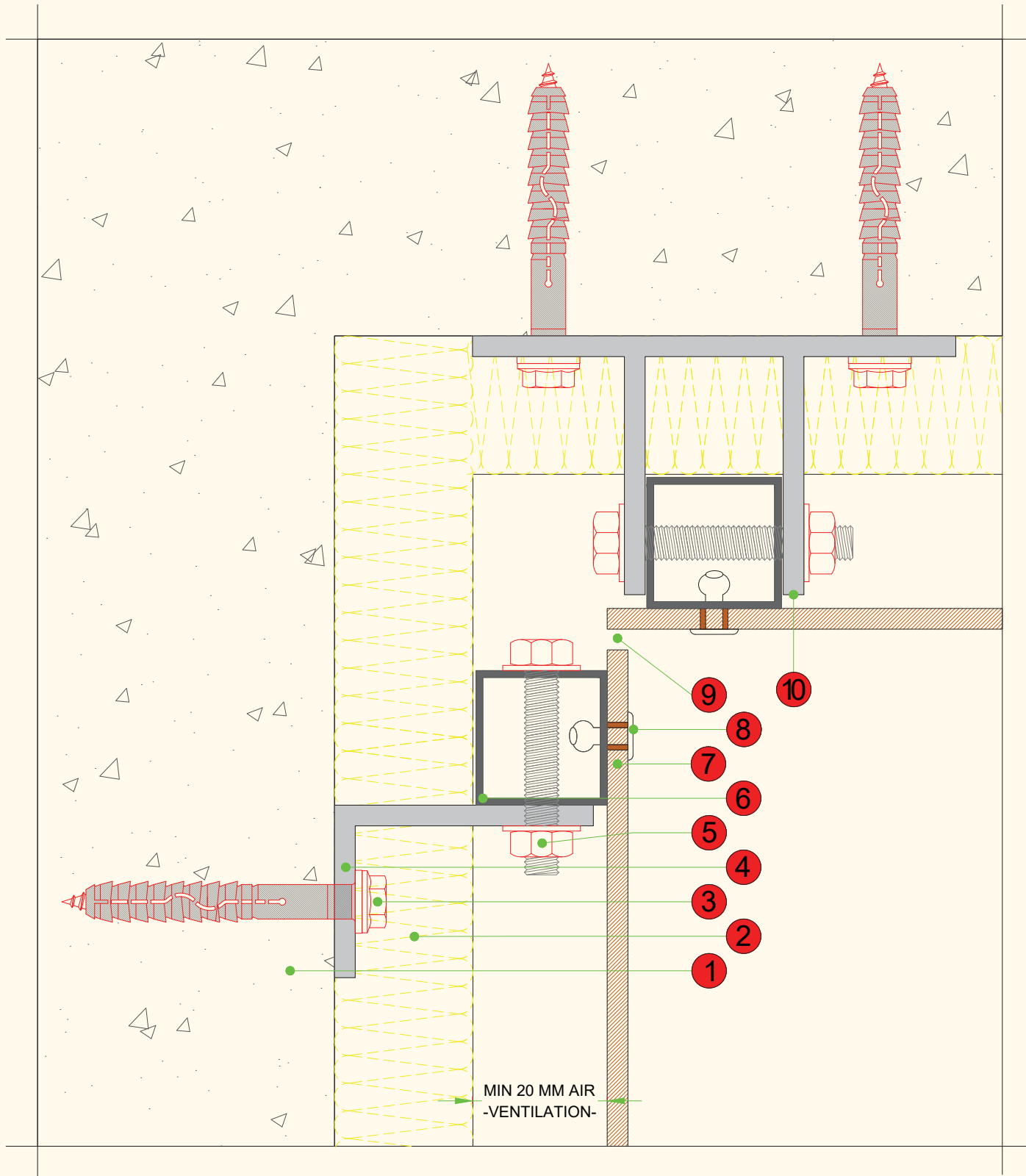

**VISIBLE FIXING. 2. RIVETED 'L - T' PROFILE SYSTEM.**

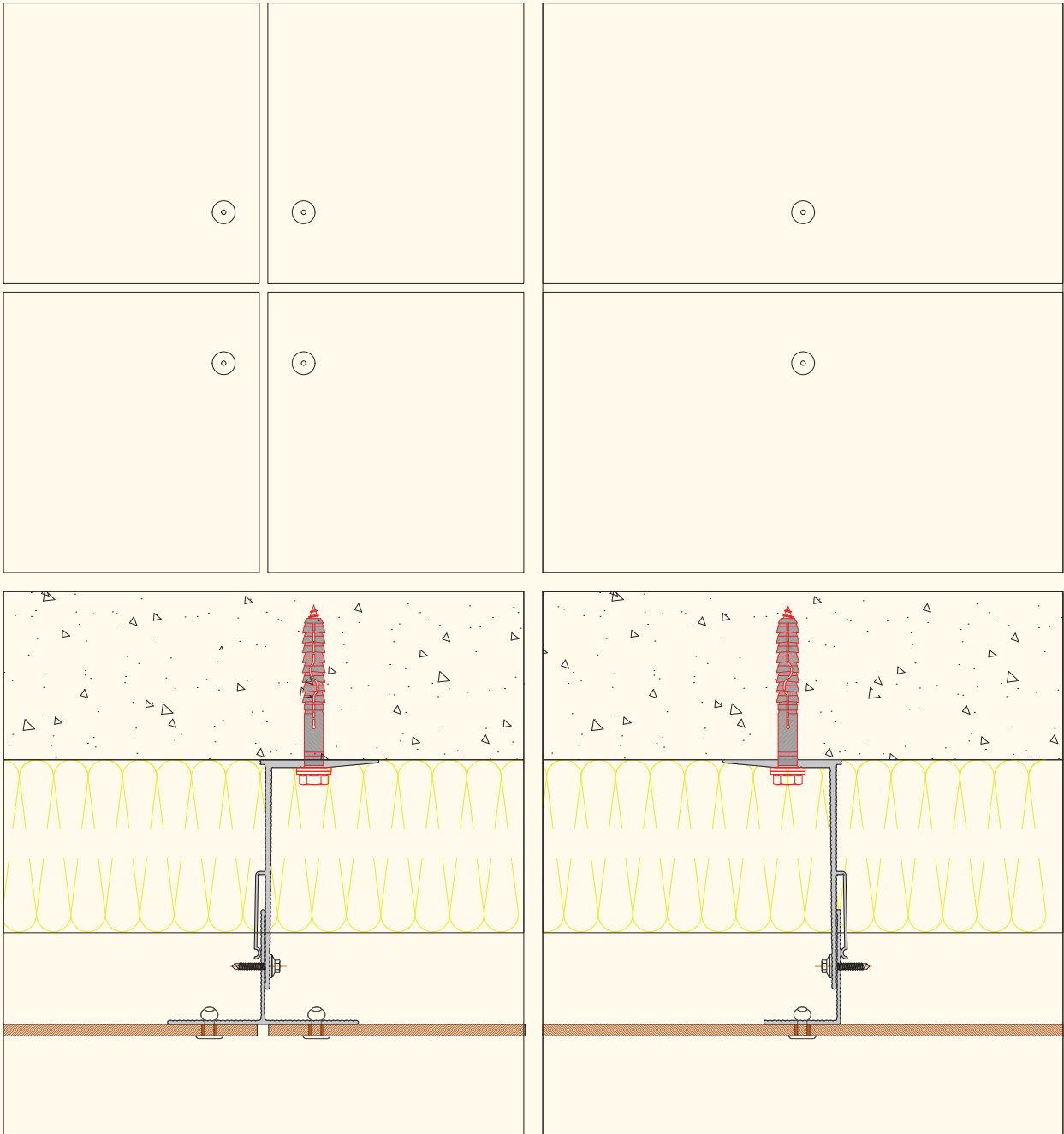

Sl. No.	Accessories	Riveted - Visible Fixing 'L - T' System	D1 - Window Lintel
1	EXISTING CONSTRUCTION		
2	INSULATION		
3	ANCHOR FASTENER		
4	ADJUSTABLE L BRACKET		
5	SELF TAPPING SCREW		
6	VERTICAL PROFILE		
7	<b>MERINO</b> ARMOUR EWC		
8	<b>MERINO</b> POP BLIND RIVET		
9	L BRACKET/ANGLE		
10	L PROFILE		
11	AIR GAP FOR VENTILATION		

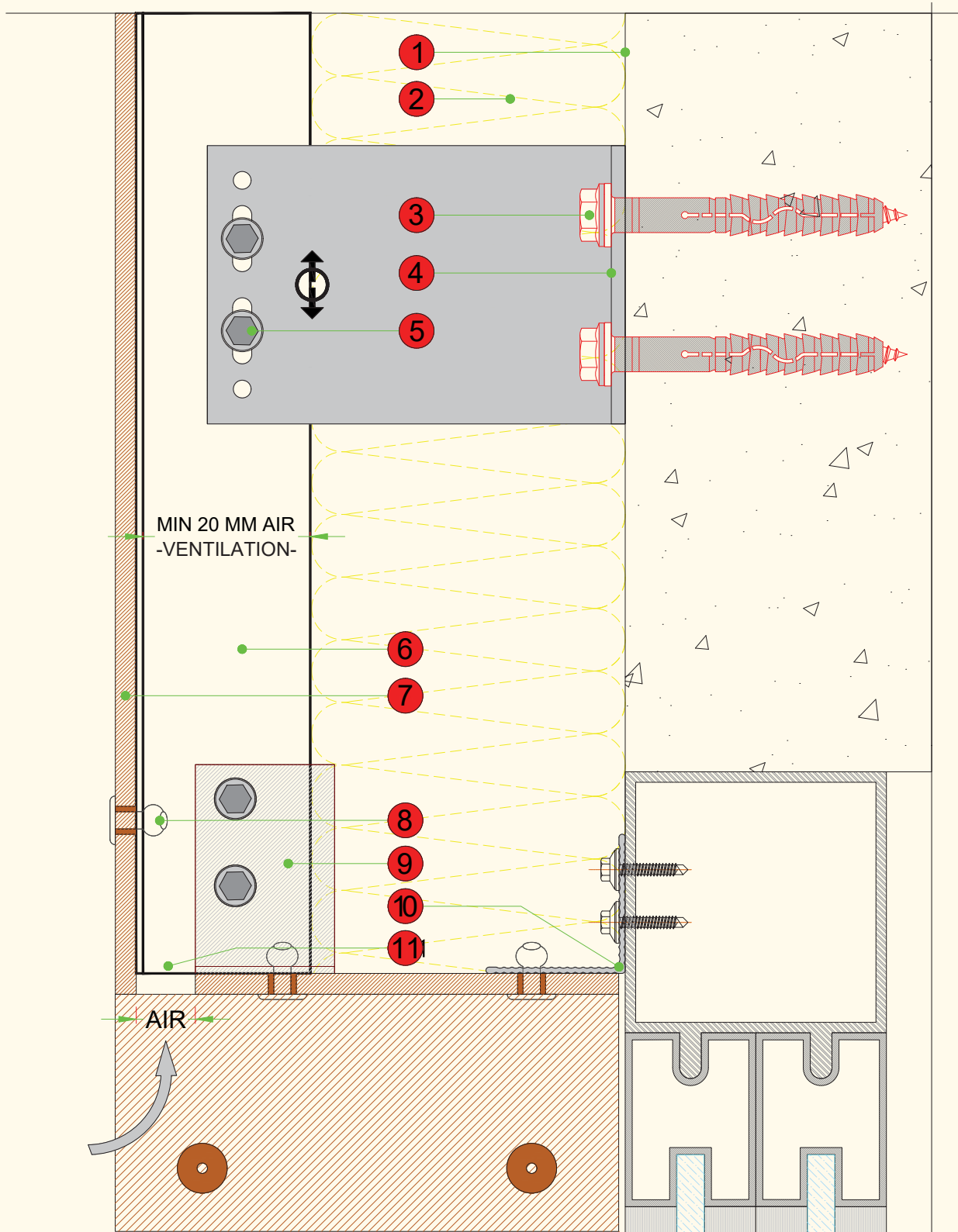

Sl. No.	Accessories	Riveted - Visible Fixing 'L - T' System	D2 - Window Reveal
1	EXISTING CONSTRUCTION		
2	INSULATION		
3	ANCHOR FASTENER		
4	ADJUSTABLE L BRACKET		
5	SELF TAPPING SCREW		
6	VERTICAL L PROFILE		
7	<b>MERINO</b> ARMOUR EWC		
8	<b>MERINO</b> POP BLIND RIVET		
9	L PROFILE		

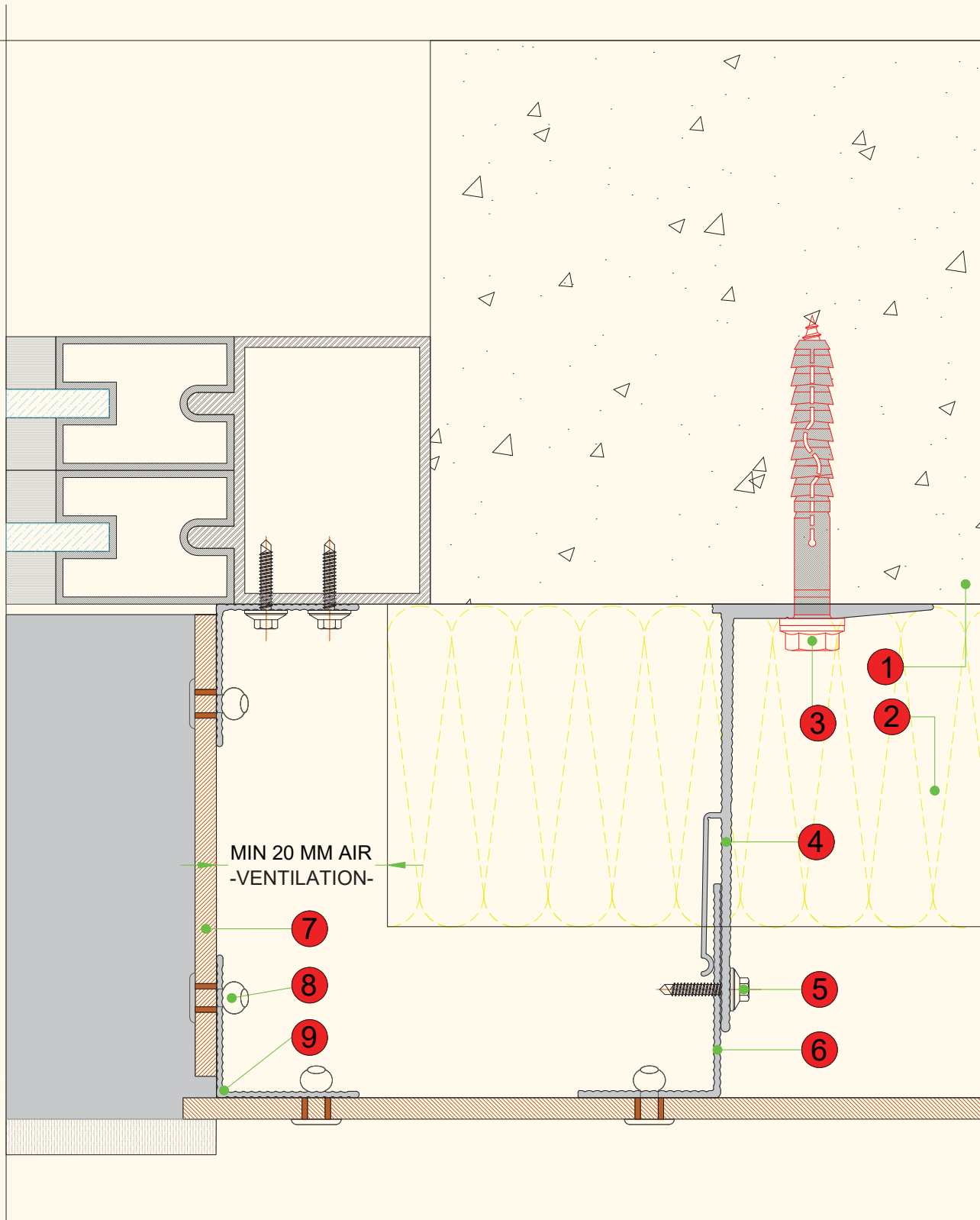



Sl. No.	Accessories	Riveted - Visible Fixing 'L - T' System	D3 - Window sill
1	EXISTING CONSTRUCTION		
2	INSULATION		
3	L BRACKET/ANGLE		
4	SELF TAPPING SCREW		
5	VERTICAL L PROFILE		
6	<b>MERINO</b> ARMOUR EWC		
7	<b>MERINO</b> POP BLIND RIVET		
8	ANCHOR FASTENER		
9	ADJUSTABLE L BRACKET		

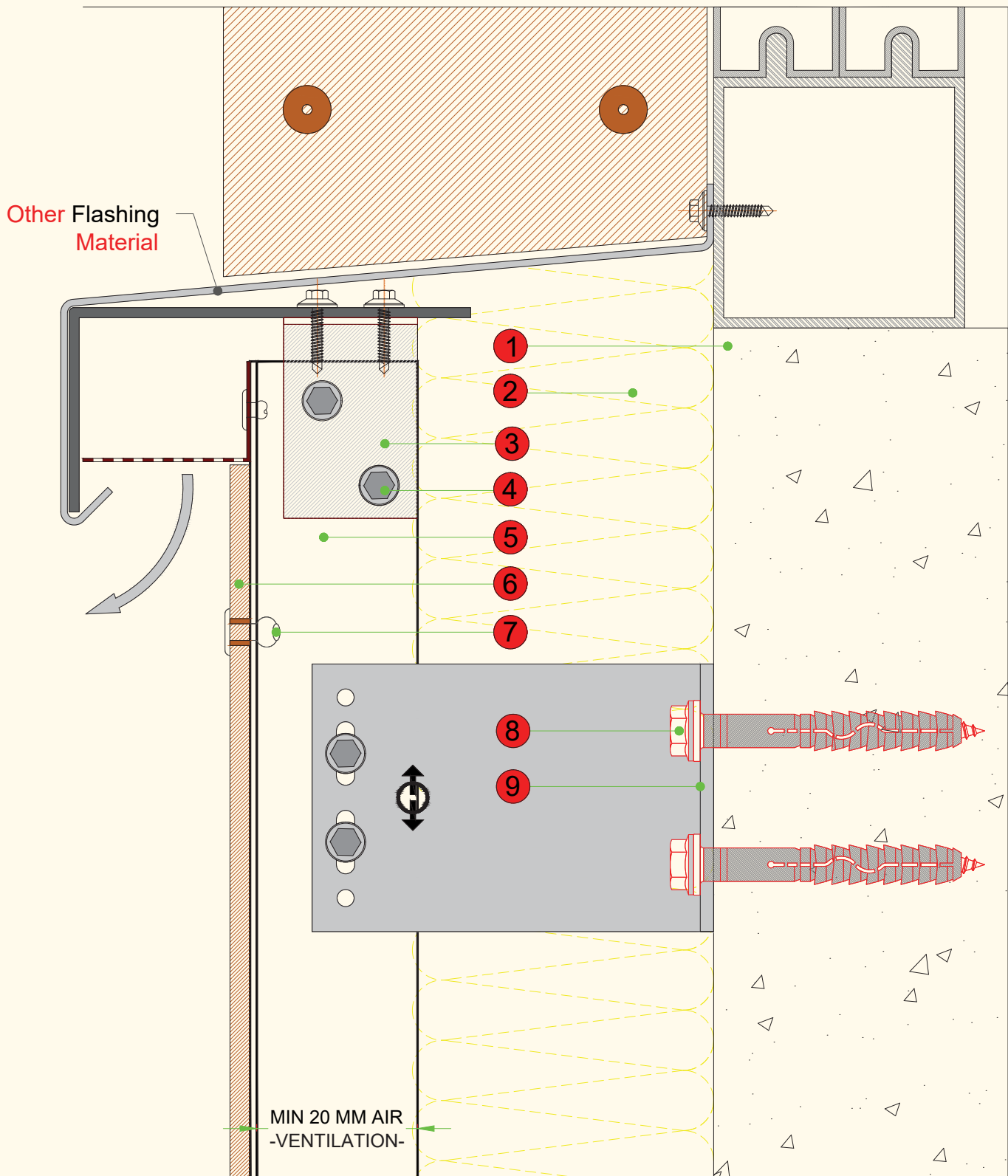



Sl. No.	Accessories	Riveted - Visible Fixing 'L - T' System	D4 - Head Details
1	EXISTING CONSTRUCTION		
2	INSULATION		
3	FLASHING BY OTHERS		
4	SELF TAPPING SCREW		
5	L BRACKET/ANGLE		
6	ANCHOR FASTENER		
7	VERTICAL PROFILE		
8	<b>MERINO</b> ARMOUR EWC		
9	<b>MERINO</b> POP BLIND RIVET		
10	ANCHOR FASTENER		
11	ADJUSTABLE L BRACKET		

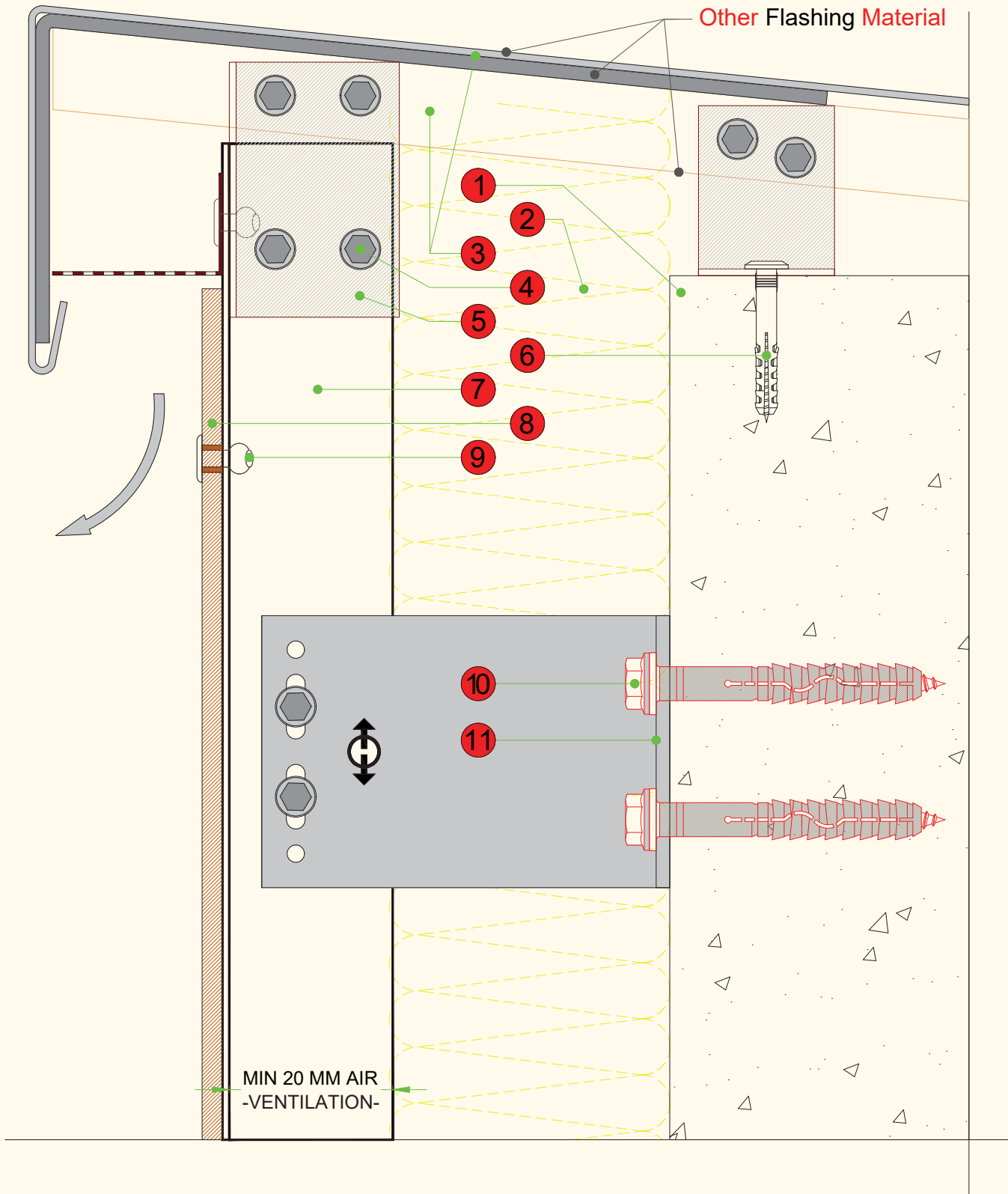

Sl. No.	Accessories	Riveted - Visible Fixing 'L - T' System	D5 - External Corner
1	EXISTING CONSTRUCTION		
2	INSULATION		
3	ADJUSTABLE L BRACKET		
4	ANCHOR FASTENER		
5	SELF TAPPING SCREW		
6	VERTICAL L PROFILE		
7	<b>MERINO</b> ARMOUR EWC		
8	<b>MERINO</b> POP BLIND RIVET		
9	L PROFILE		

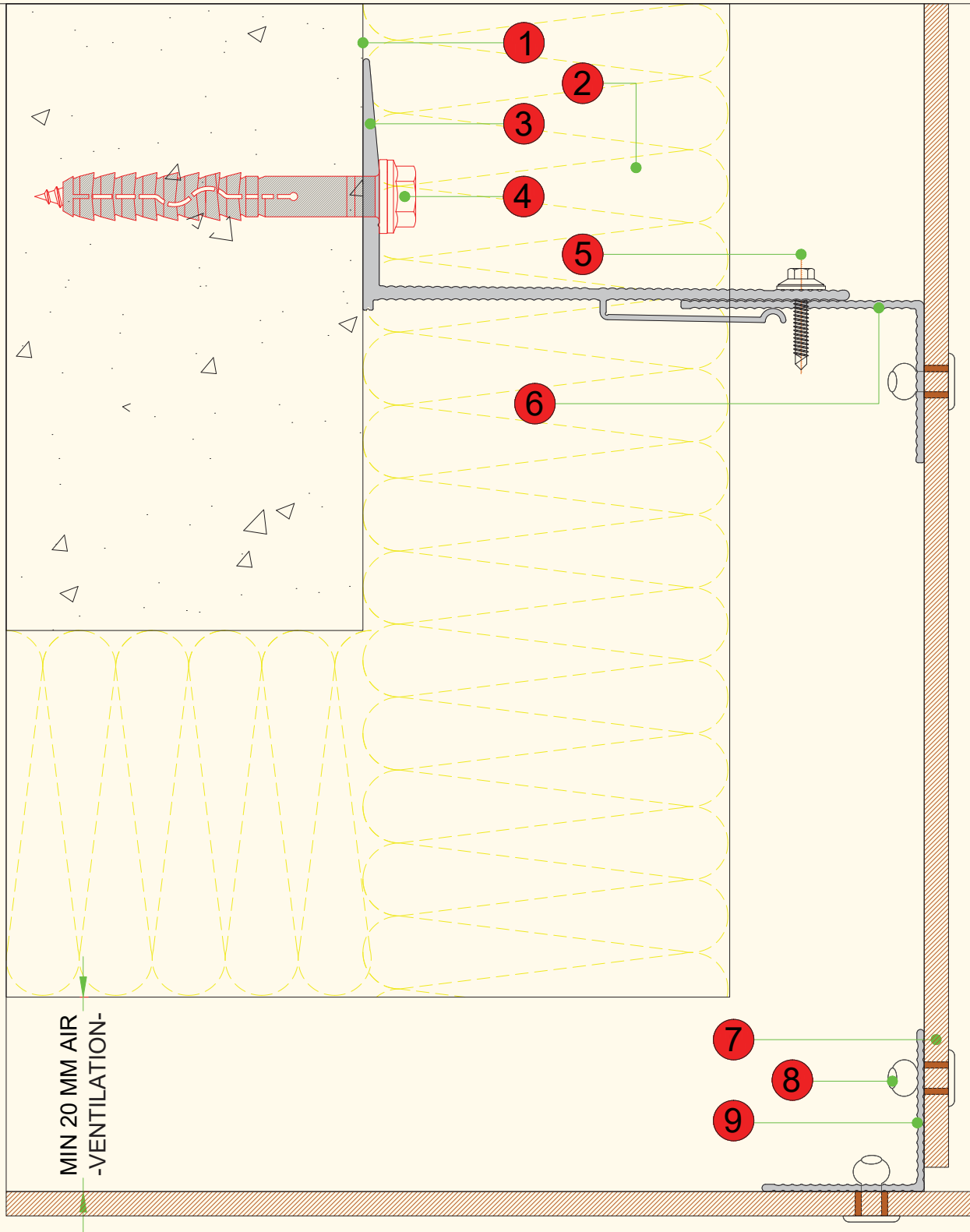

Sl. No.	Accessories	Riveted - Visible Fixing 'L - T' System	D6 - Vertical section
1	EXISTING CONSTRUCTION		
2	INSULATION		
3	ANCHOR FASTENER		
4	ADJUSTABLE L BRACKET		
5	SELF TAPPING SCREW		
6	VERTICAL L PROFILE		
7	<b>MERINO</b> POP BLIND RIVET		
8	<b>MERINO</b> ARMOUR EWC		

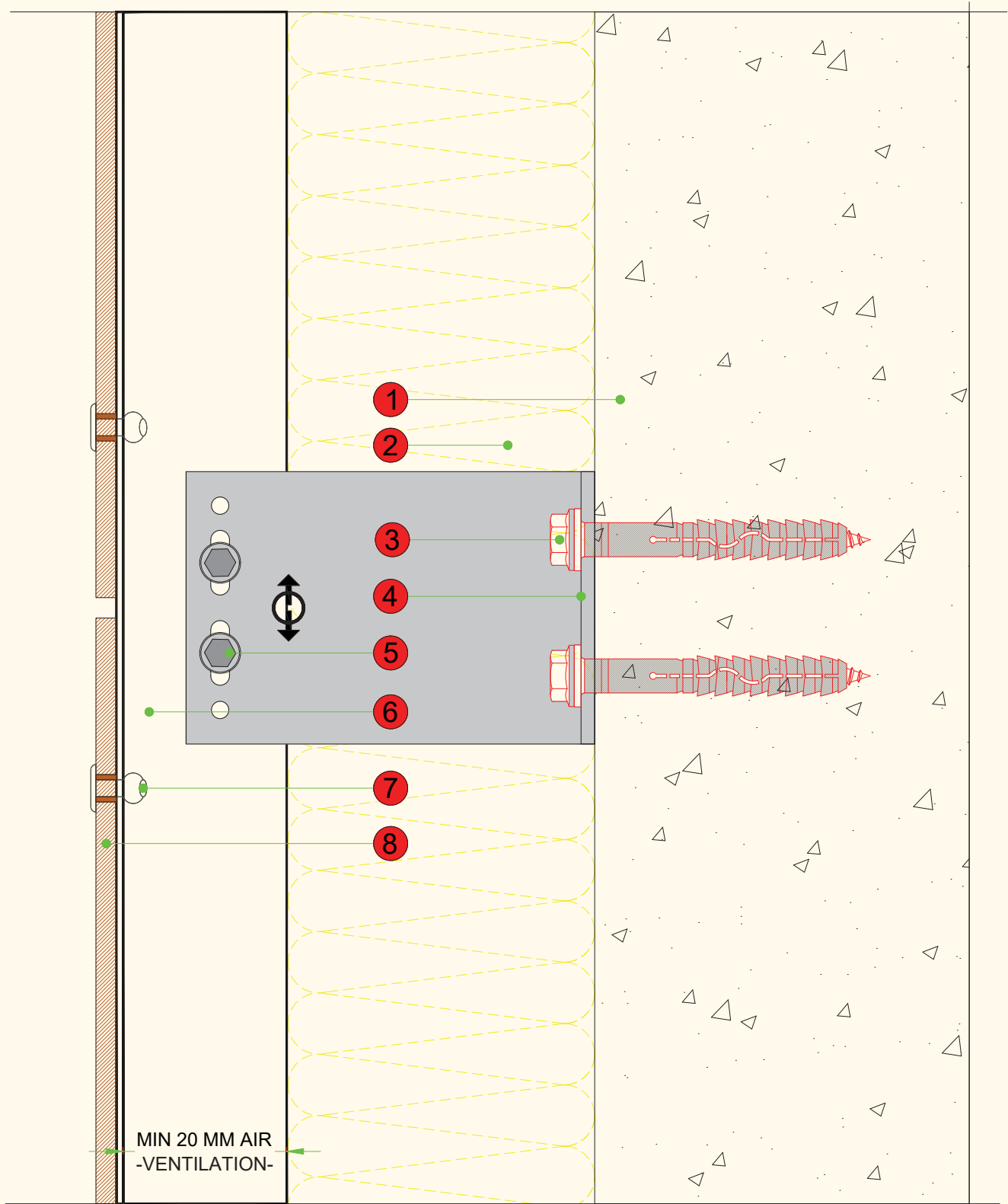

Sl. No.	Accessories	Riveted - Visible Fixing 'L - T' System	D7 - Horizontal section
1	EXISTING CONSTRUCTION		
2	INSULATION		
3	ANCHOR FASTENER		
4	ADJUSTABLE L BRACKET		
5	SELF TAPPING SCREW		
6	VERTICAL T PROFILE		
7	<b>MERINO</b> ARMOUR EWC		
8	<b>MERINO</b> POP BLIND RIVET		
9	AIR CIRCULATION GAP		

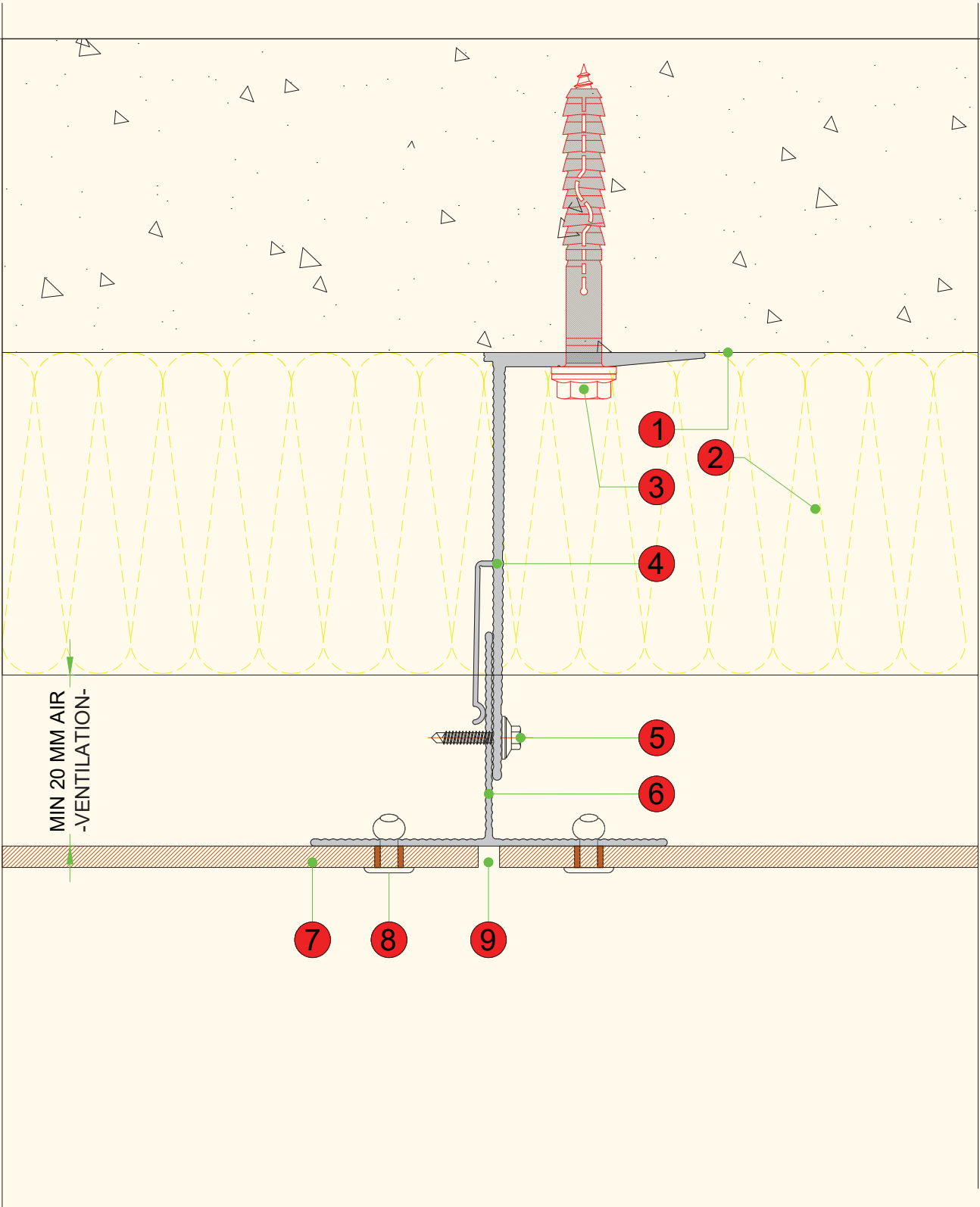

Sl. No.	Accessories	Riveted - Visible Fixing 'L - T' System	D8 - Base details
1	EXISTING CONSTRUCTION		
2	INSULATION		
3	ANCHOR FASTENER		
4	ADJUSTABLE L BRACKET		
5	SELF TAPPING SCREW		
6	VERTICAL L PROFILE		
7	AIR FLOW L PROFILE/RAIL		
8	<b>MERINO</b> ARMOUR EWC		
9	<b>MERINO</b> POP BLIND RIVET		
10	ANCHOR FASTENER		
11	L PROFILE/RAIL		

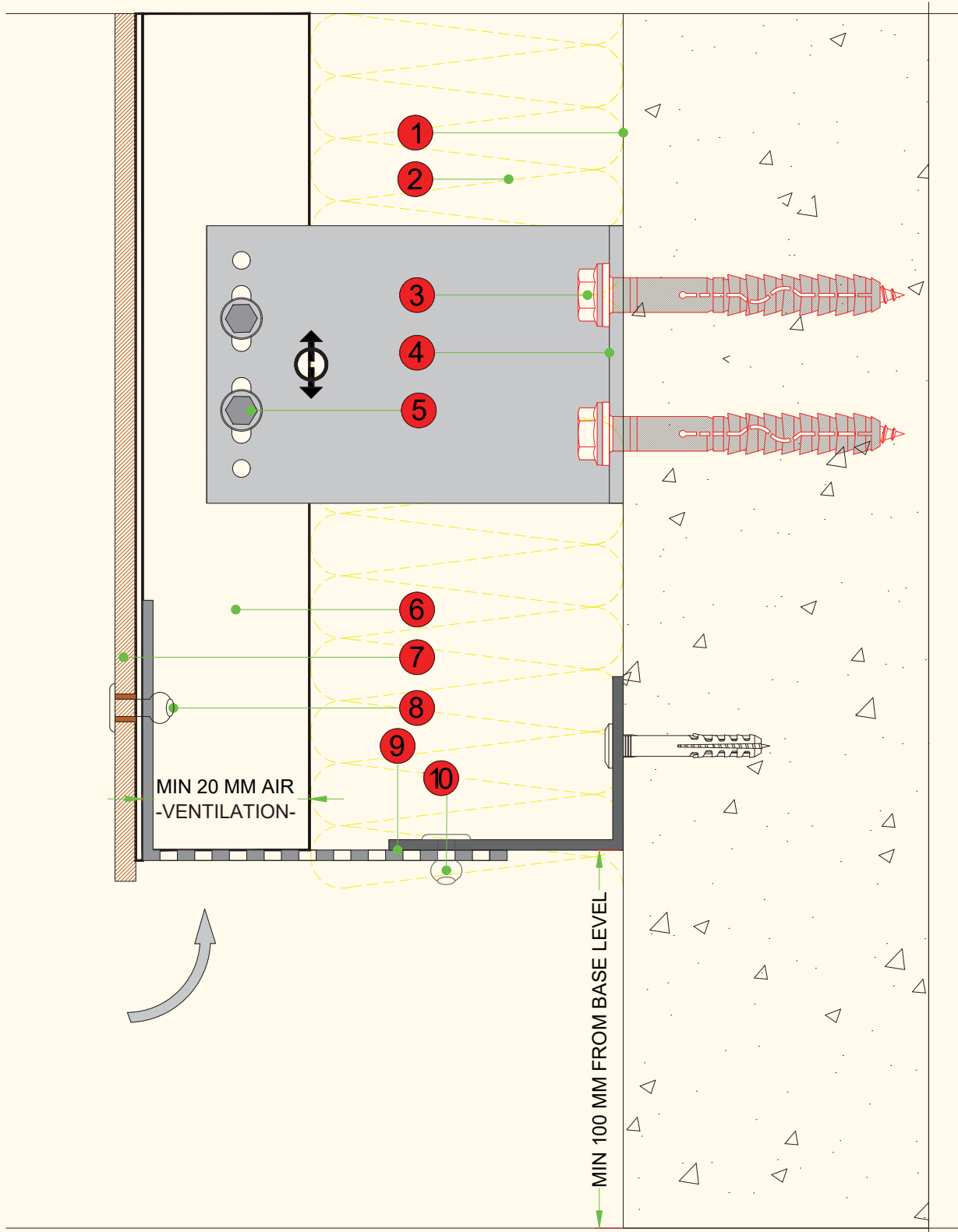



Sl. No.	Accessories	Riveted - Visible Fixing 'L - T' System	D9 - Internal Corner
1	EXISTING CONSTRUCTION		
2	INSULATION		
3	ANCHOR FASTENER		
4	ADJUSTABLE L BRACKET		
5	SELF TAPPING SCREW		
6	CORNER L PROFILE		
7	VERTICAL L PROFILE		
8	<b>MERINO</b> ARMOUR EWC		
9	<b>MERINO</b> POP BLIND RIVET		

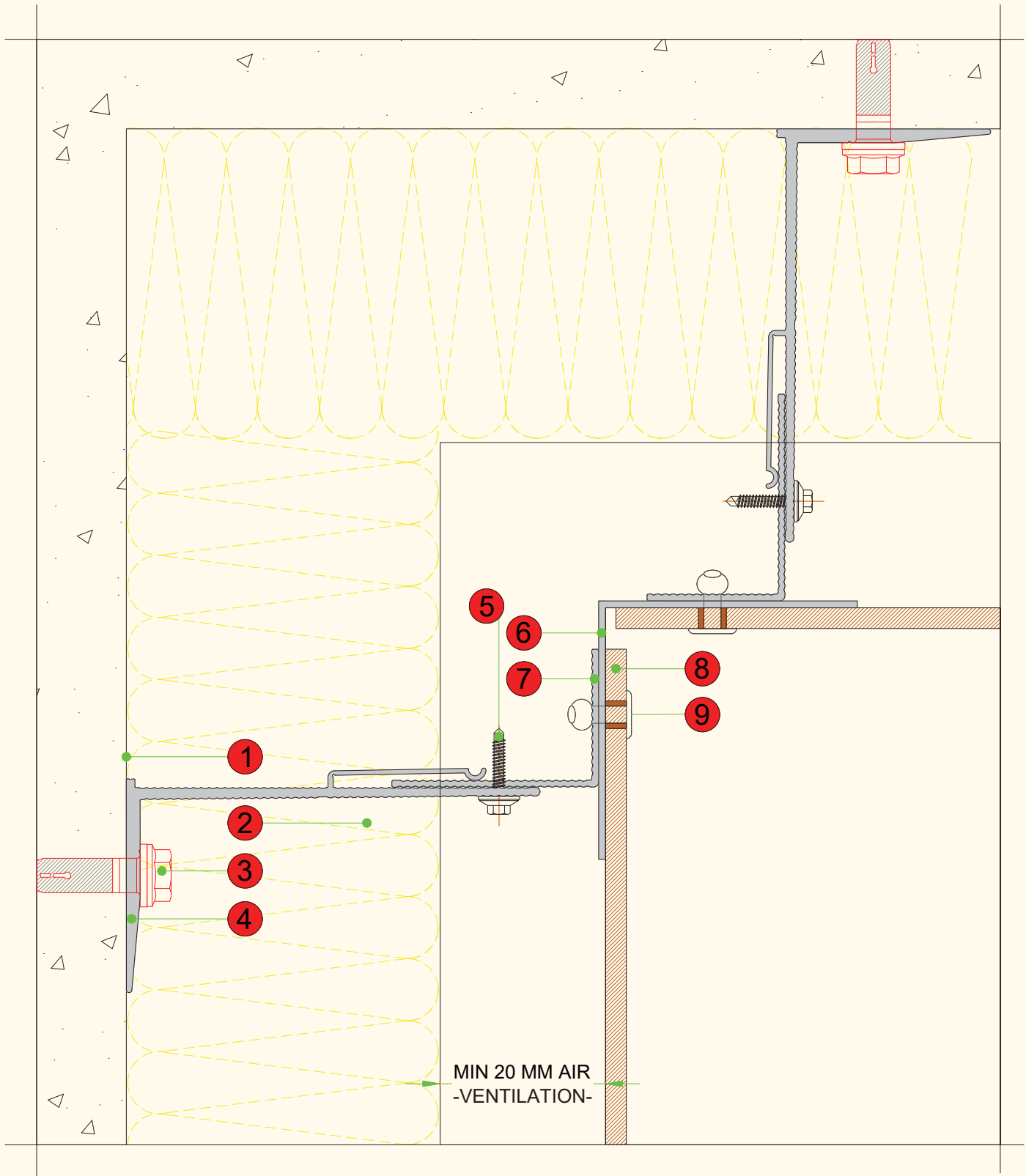



**VISIBLE FIXING. 3. RIVETED 'J & U' PROFILE SYSTEM.**

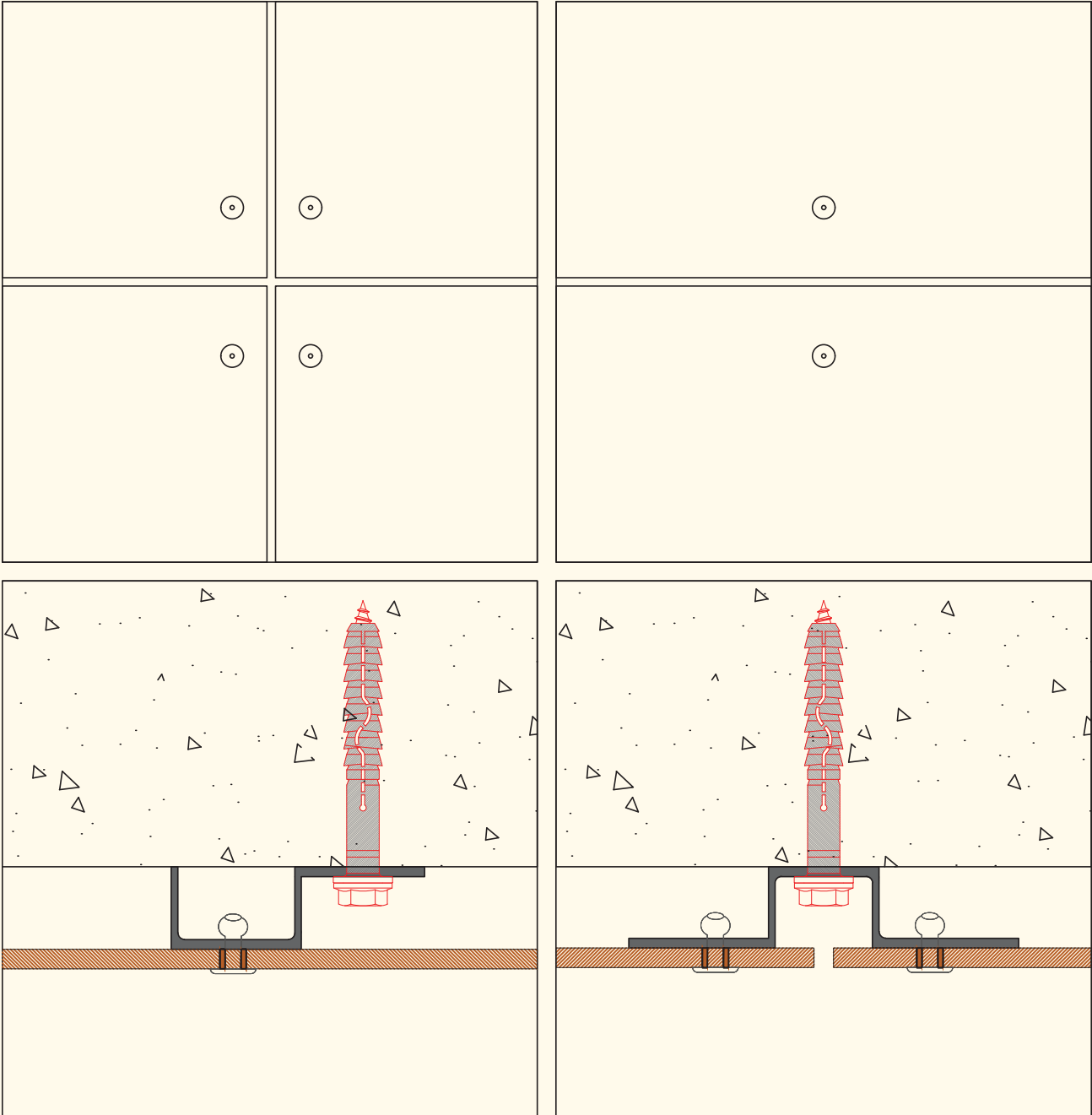

Sl. No.	Accessories	Riveted - Visible Fixing 'J & U' System	D1 - Window Lintel
1	EXISTING CONSTRUCTION		
2	ANCHOR FASTENER		
3	J PROFILE		
4	<b>MERINO</b> ARMOUR EWC		
5	<b>MERINO</b> POP BLIND RIVET		
6	SELF TAPPING SCREW		
7	PERFORATED L PROFILE		

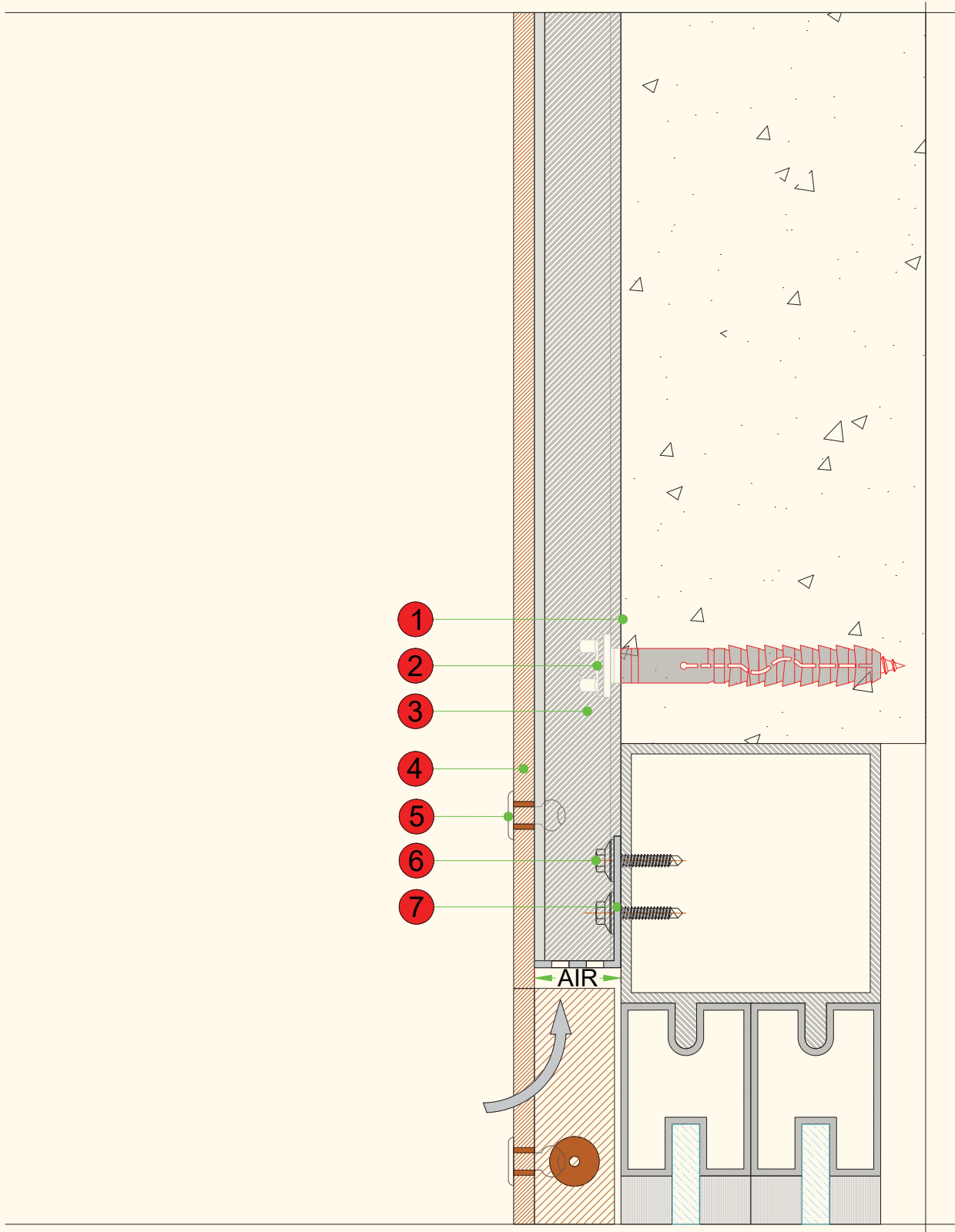

Sl. No.	Accessories	Riveted - Visible Fixing 'J & U' System	D2 - Window Reveal
1	EXISTING CONSTRUCTION		
2	ANCHOR FASTENER		
3	J PROFILE		
4	<b>MERINO</b> ARMOUR EWC		
5	<b>MERINO</b> POP BLIND RIVET		
6	6 MM V GROOVE		
7	FLASHING BY OTHERS		

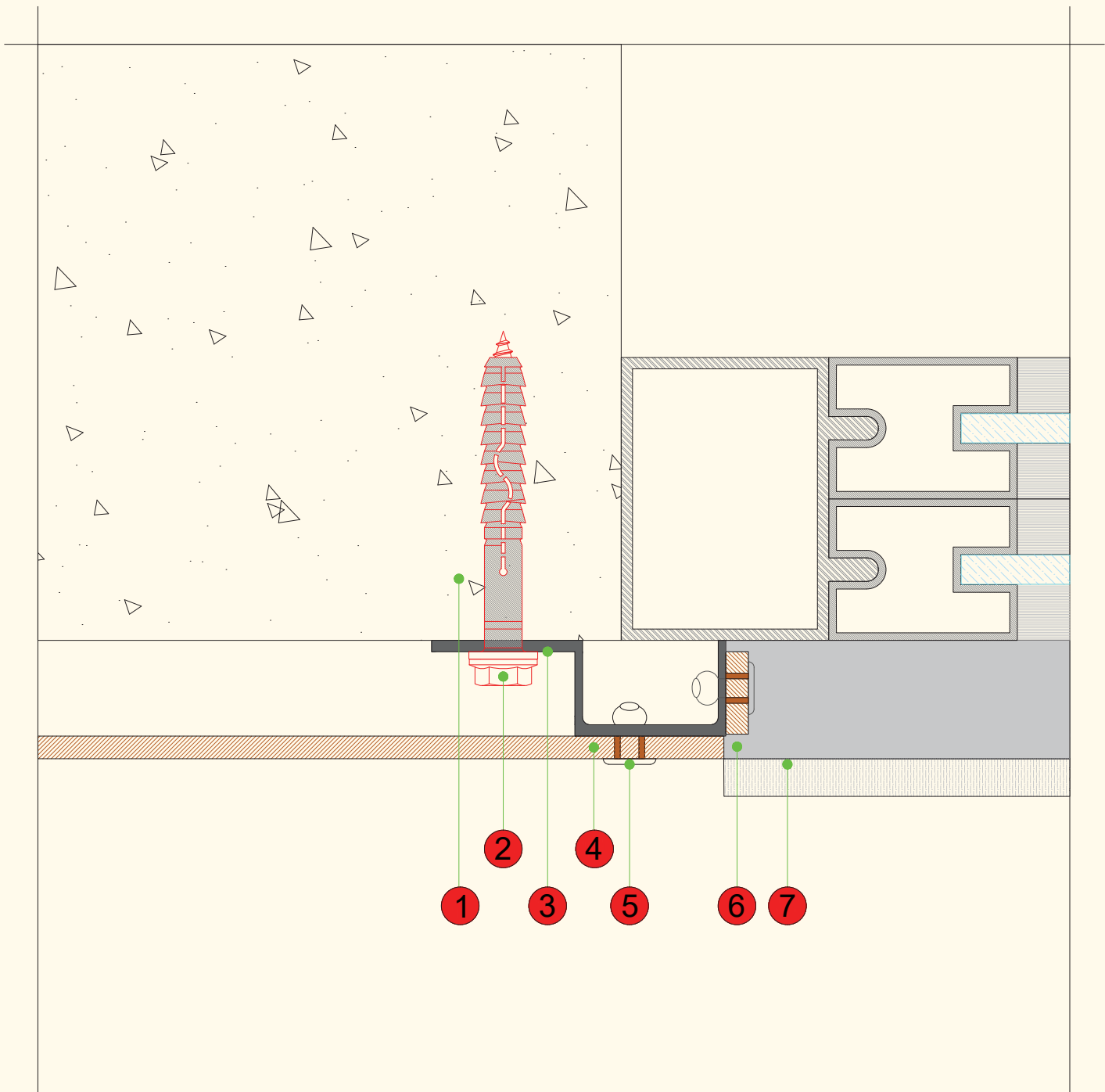

Sl. No.	Accessories	Riveted - Visible Fixing 'J & U' System	D3 - Window sill
1	EXISTING CONSTRUCTION		
2	ANCHOR FASTENER		
3	J PROFILE		
4	<b>MERINO</b> ARMOUR EWC		
5	<b>MERINO</b> POP BLIND RIVET		
6	FLASHING BY OTHERS		

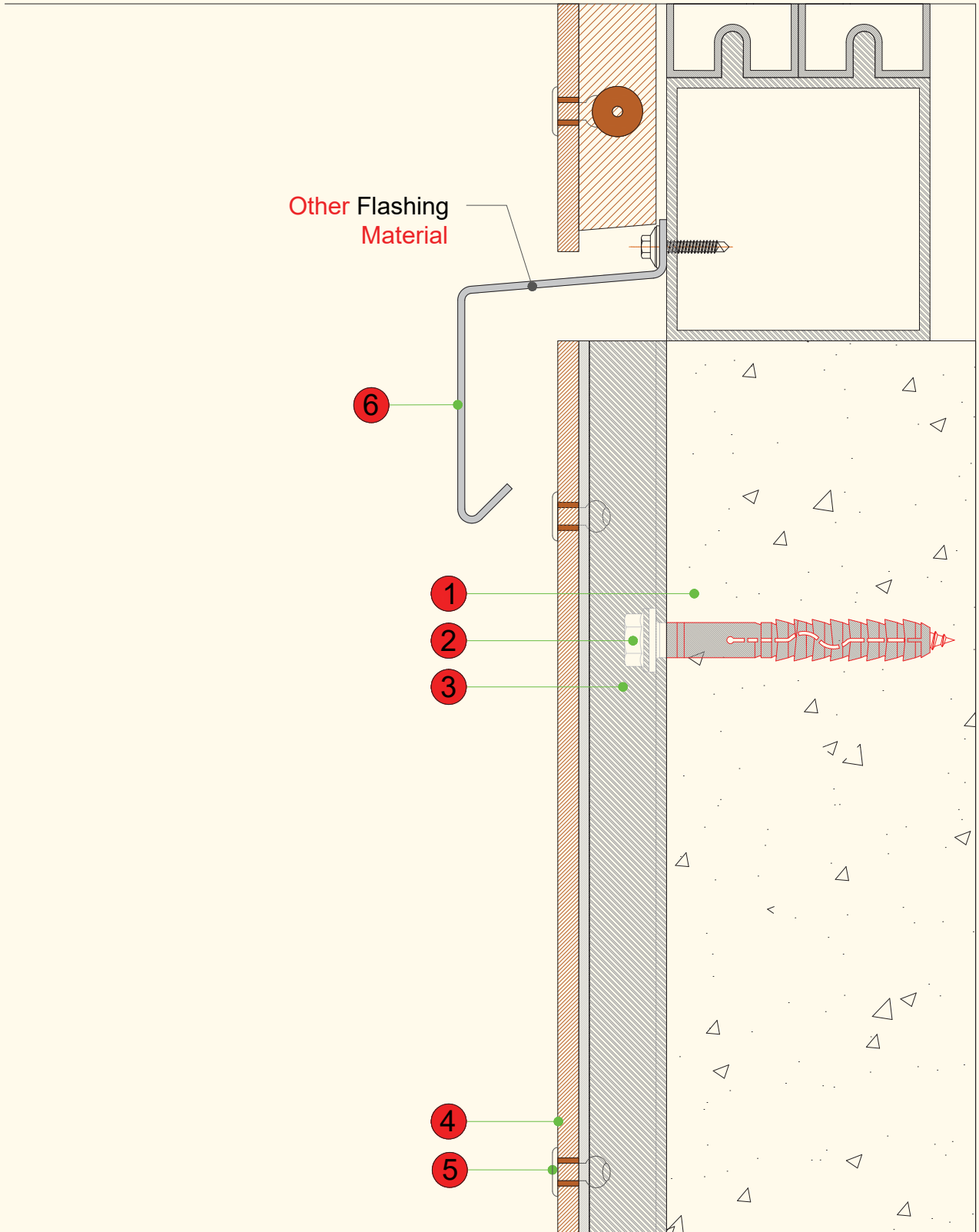

Sl. No.	Accessories	Riveted - Visible Fixing 'J & U' System	D4 - Head Details
1	EXISTING CONSTRUCTION		
2	ANCHOR FASTENER		
3	J PROFILE		
4	<b>MERINO</b> ARMOUR EWC		
5	<b>MERINO</b> POP BLIND RIVET		
6	FLASHING BY OTHERS		

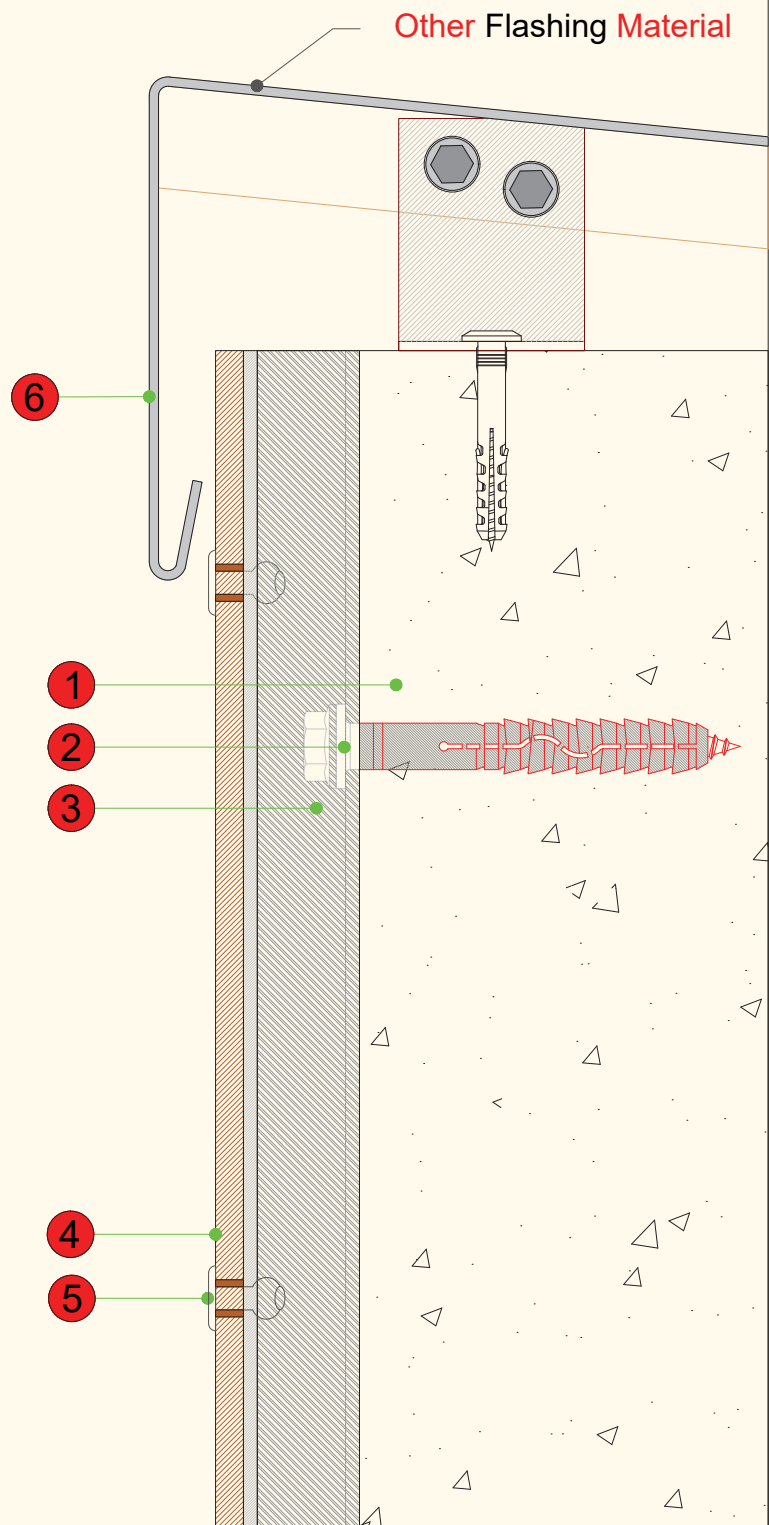



Sl. No.	Accessories	Riveted - Visible Fixing 'J & U' System	D5 - External Corner
1	EXISTING CONSTRUCTION		
2	ANCHOR FASTENER		
3	J PROFILE		
4	<b>MERINO</b> ARMOUR EWC		
5	<b>MERINO</b> POP BLIND RIVET		
6	6 MM GROOVE		

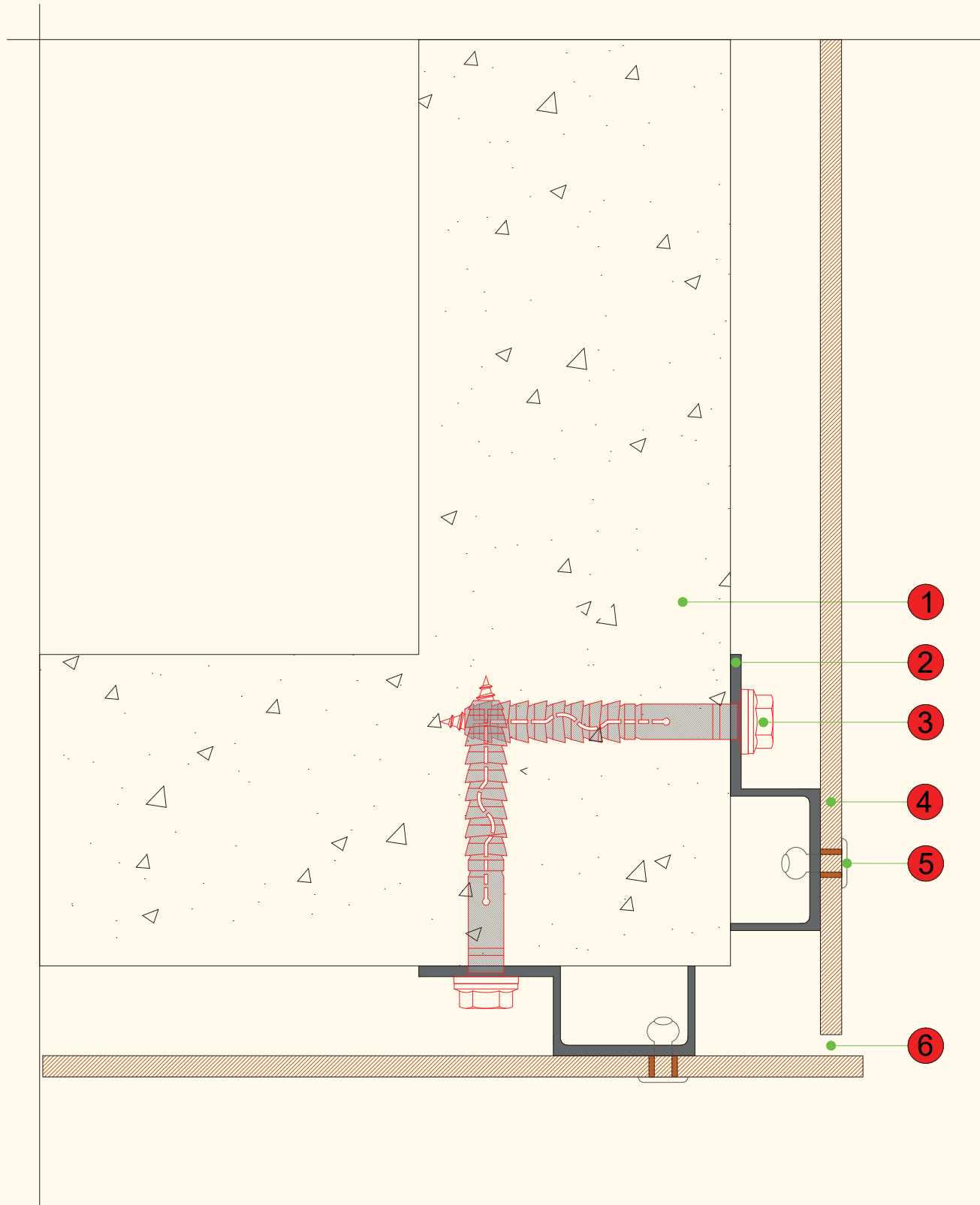



Sl. No.	Accessories	Riveted - Visible Fixing 'J & U' System	D6 - Vertical section
1	EXISTING CONSTRUCTION		
2	ANCHOR FASTENER		
3	J PROFILE		
4	<b>MERINO</b> ARMOUR EWC		
5	<b>MERINO</b> POP BLIND RIVET		
6	6 MM GROOVE		

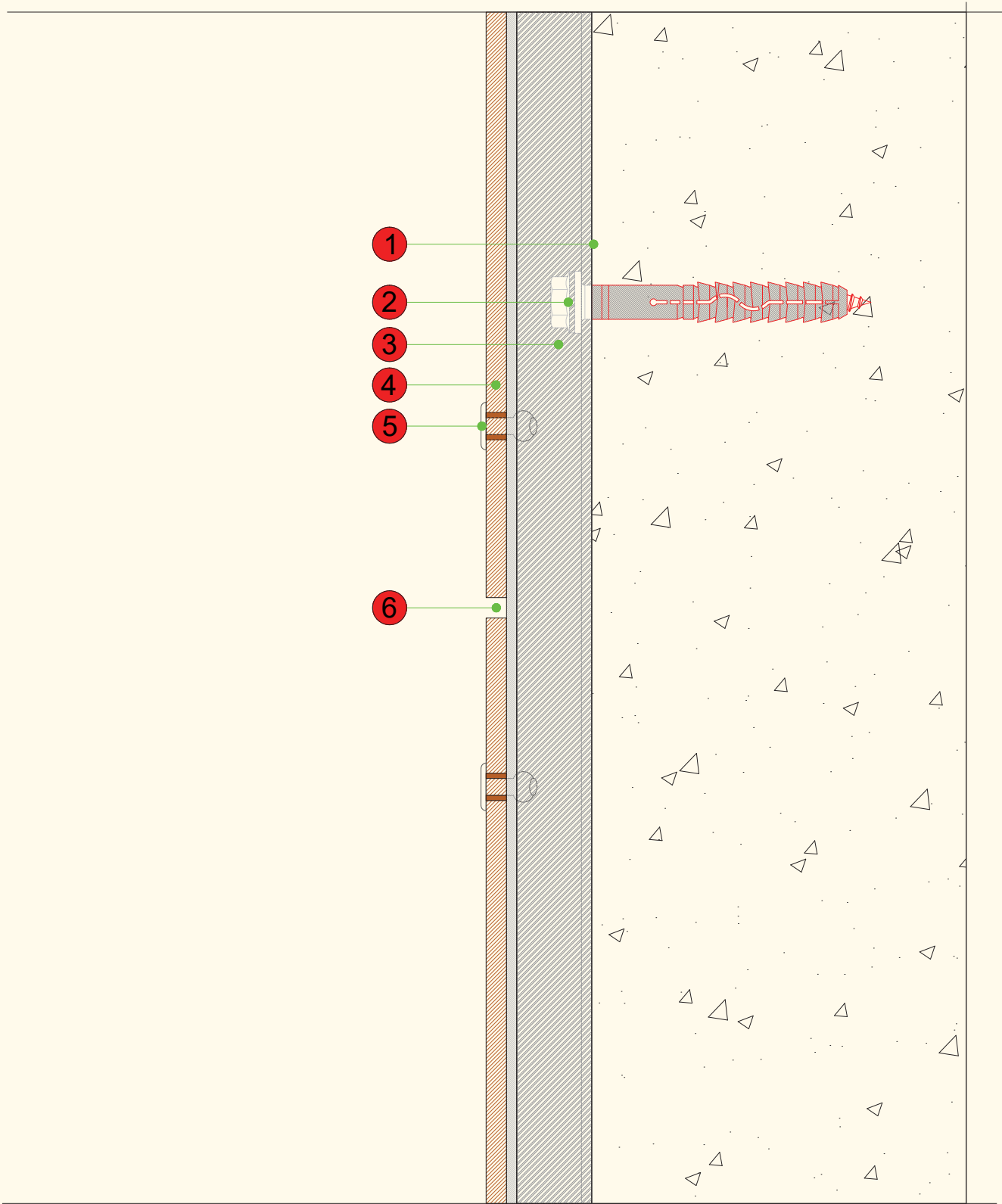

Sl. No.	Accessories	Riveted - Visible Fixing 'J & U' System	D7 - Horizontal section
1	EXISTING CONSTRUCTION		
2	ANCHOR FASTENER		
3	6 MM GROOVE		
4	U PROFILE		
5	<b>MERINO</b> ARMOUR EWC		
6	<b>MERINO</b> POP BLIND RIVET		

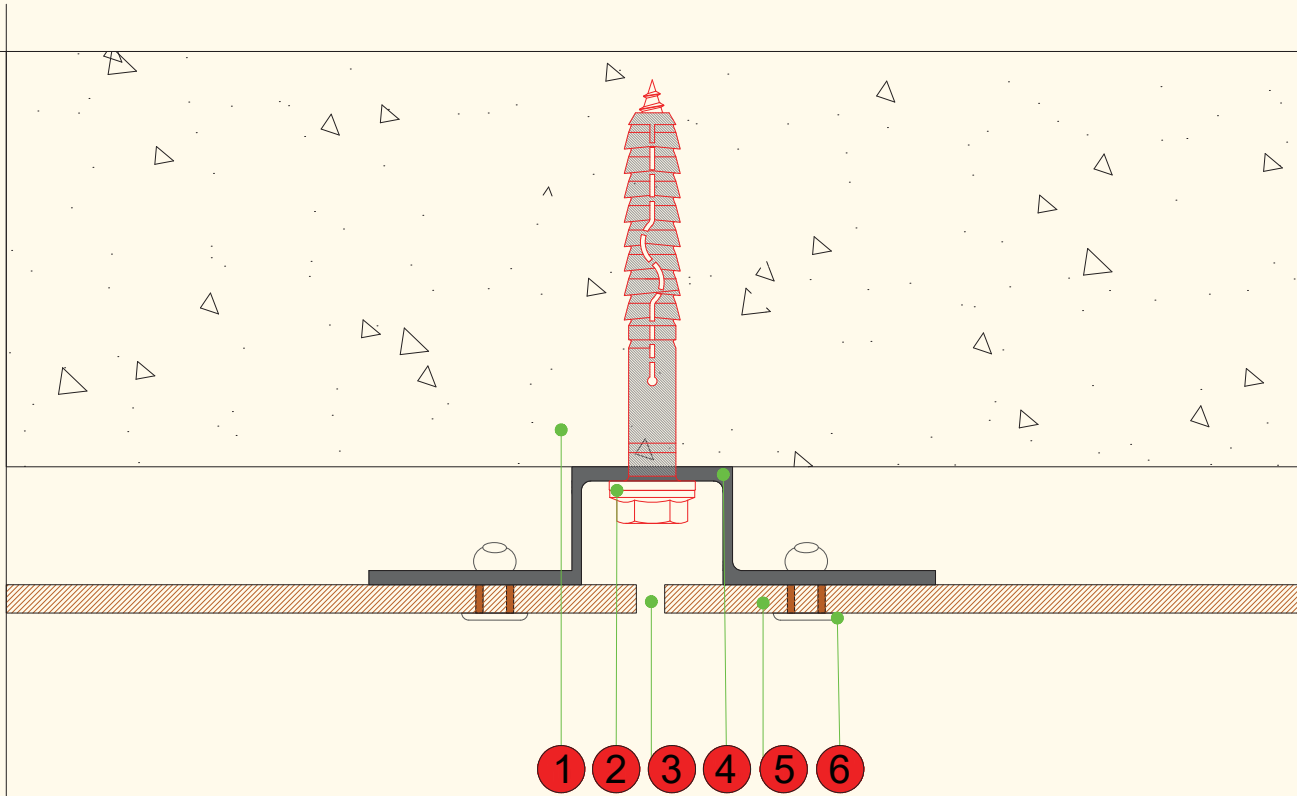

Sl. No.	Accessories	Riveted - Visible Fixing 'J & U' System	D8 - Base details
1	EXISTING CONSTRUCTION		
2	ANCHOR FASTENER		
3	J PROFILE		
4	<b>MERINO</b> ARMOUR EWC		
5	<b>MERINO</b> POP BLIND RIVET		
6	ANCHOR FASTENER		
7	PERFORATED L PROFILE		

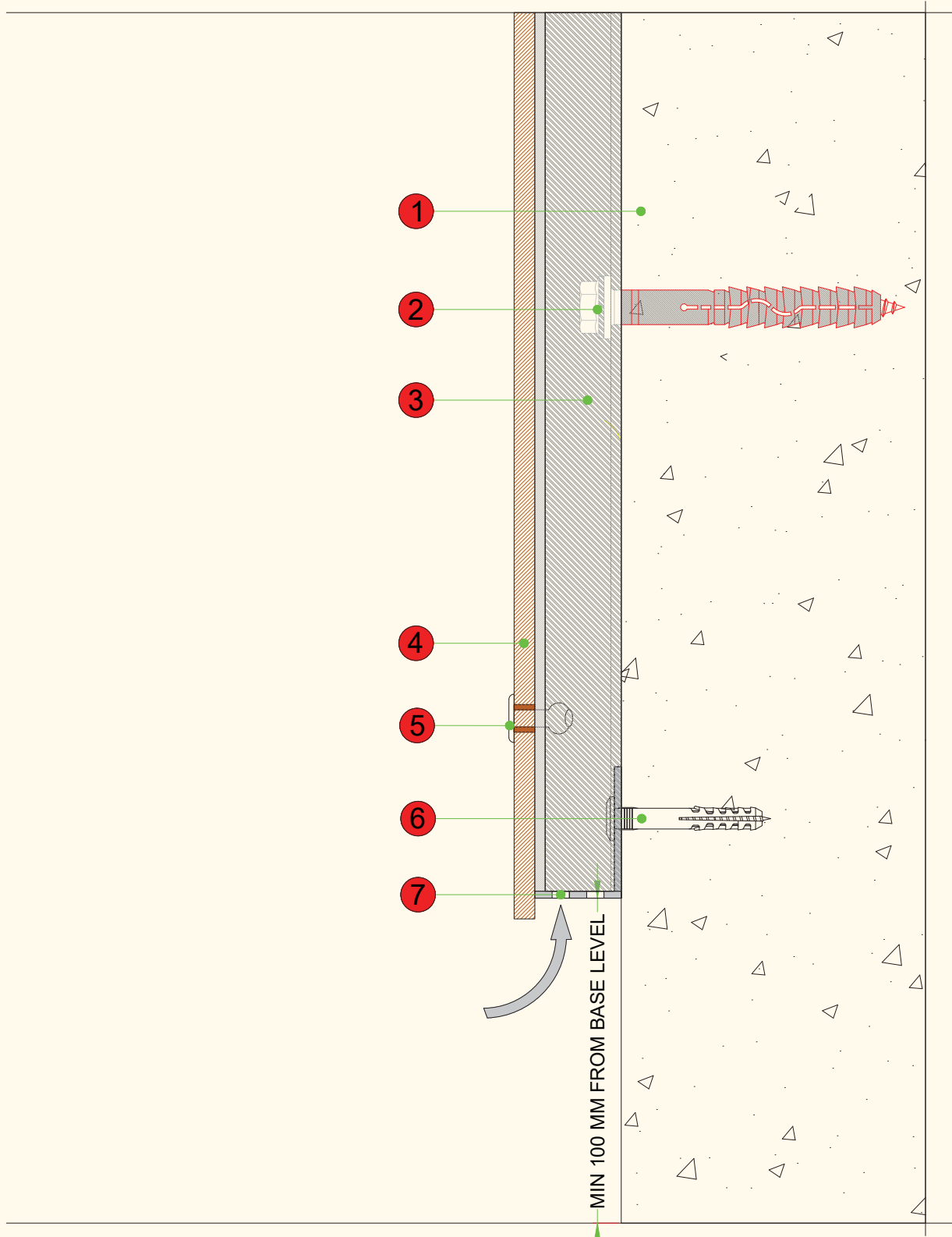

Sl. No.	Accessories	Riveted - Visible Fixing 'J & U' System	D9 - Internal Corner
1	EXISTING CONSTRUCTION		
2	ANCHOR FASTENER		
3	J PROFILE		
4	<b>MERINO</b> ARMOUR EWC		
5	<b>MERINO</b> POP BLIND RIVET		
6	6 MM GROOVE		

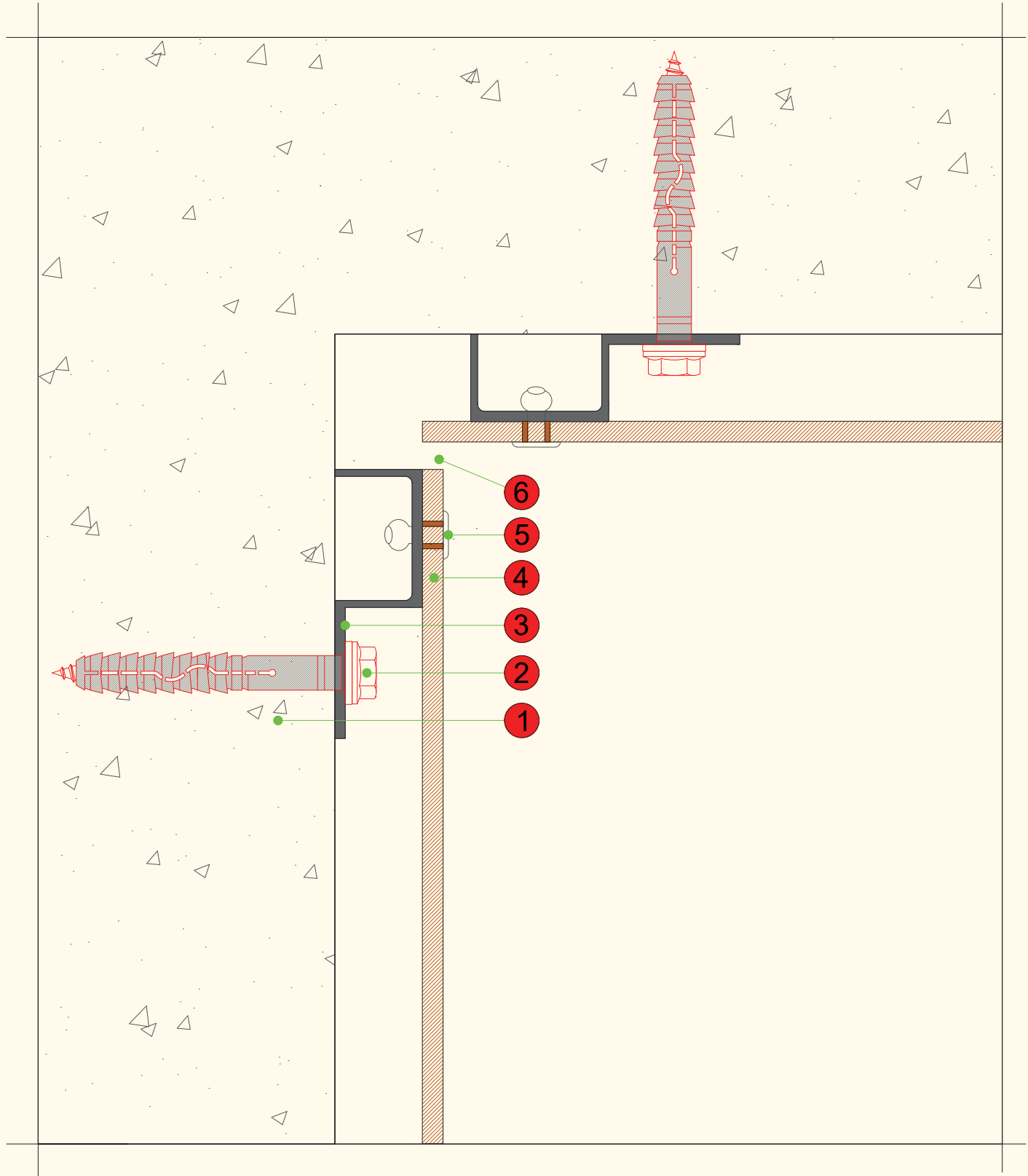

# 1 - CONCEALED FIXING ADHESIVE SYSTEM

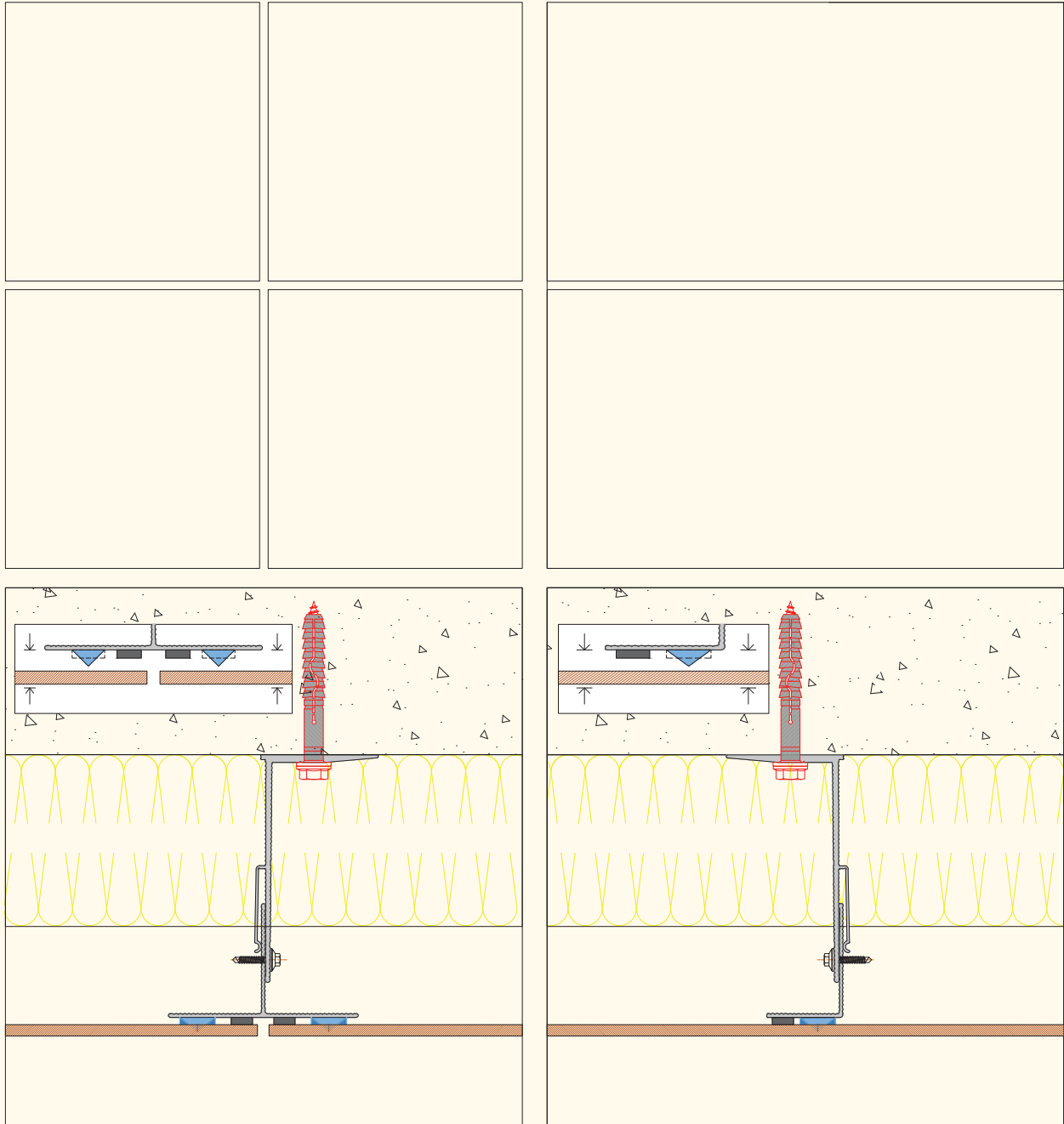





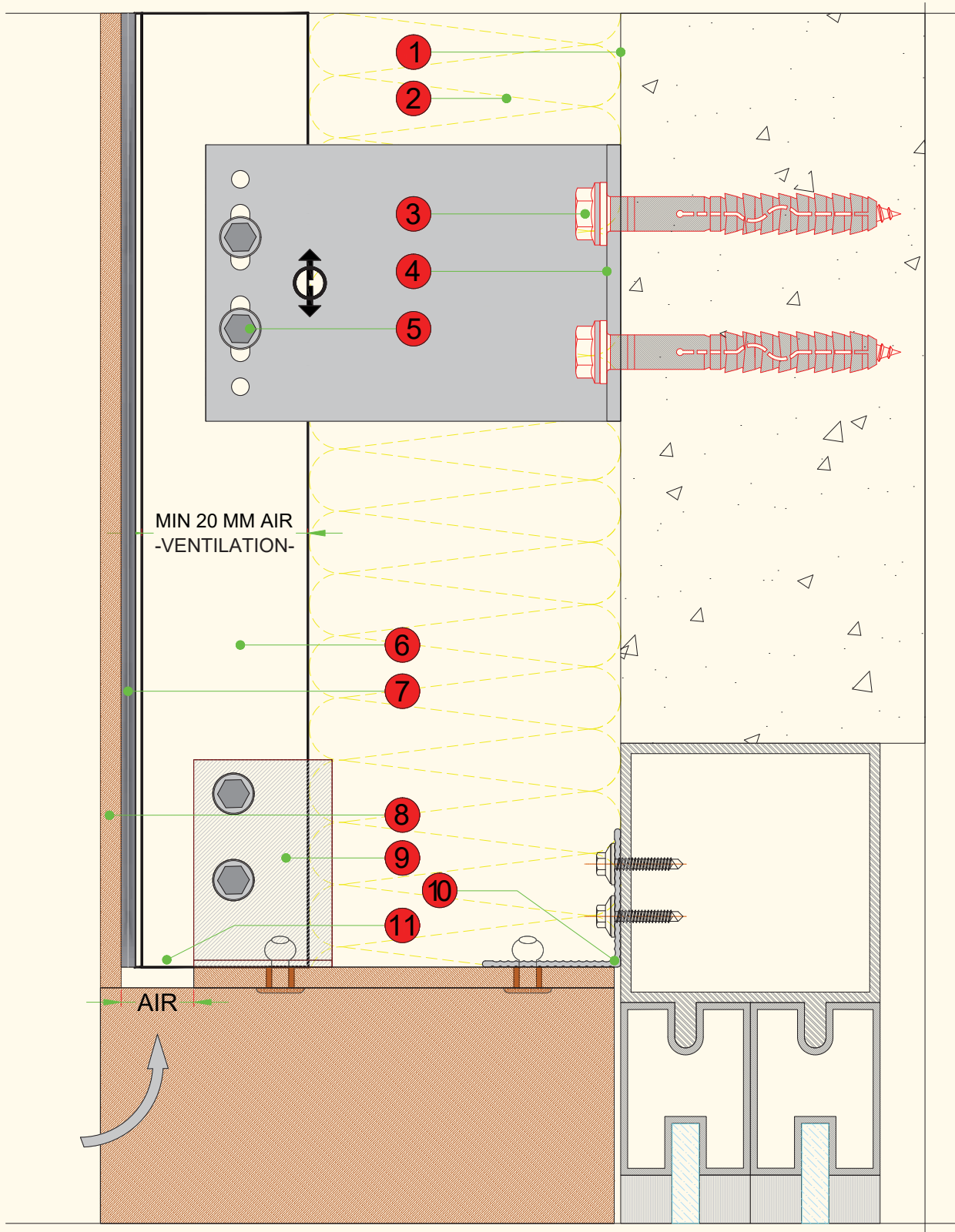

Sl. No.	Accessories	Concealed Fixing 'Adhesive' System	D1 - Window Lintel
1	EXISTING CONSTRUCTION		
2	INSULATION		
3	ANCHOR FASTENER		
4	ADJUSTABLE L BRACKET		
5	SELF TAPPING SCREW		
6	VERTICAL PROFILE		
7	DOUBLE SIDED TAPE & SILICONE		
8	<b>MERINO</b> ARMOUR EWC		
9	L BRACKET/ANGLE		
10	L PROFILE		
11	AIR GAP FOR VENTILATION		





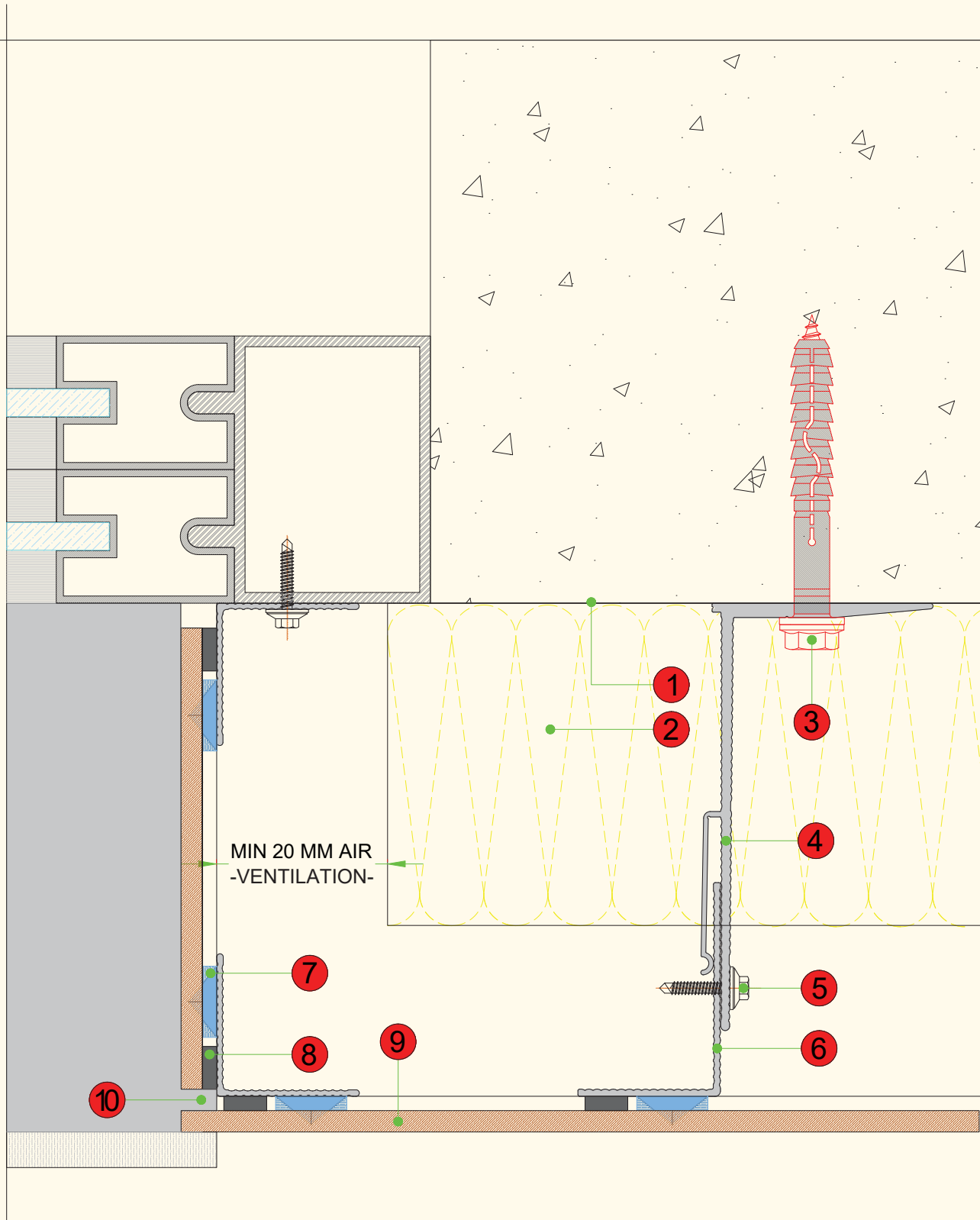

Sl. No.	Accessories	Concealed Fixing 'Adhesive' System	D2 - Window Reveal
1	EXISTING CONSTRUCTION		
2	INSULATION		
3	ANCHOR FASTENER		
4	ADJUSTABLE L BRACKET		
5	SELF TAPPING SCREW		
6	VERTICAL L PROFILE		
7	DOWSIL 896 SILICONE SEALANT		
8	DOUBLE SIDED ADHESIVE TAPE		
9	<b>MERINO</b> ARMOUR EWC		
10	GAP FOR AIR CIRCULATION		

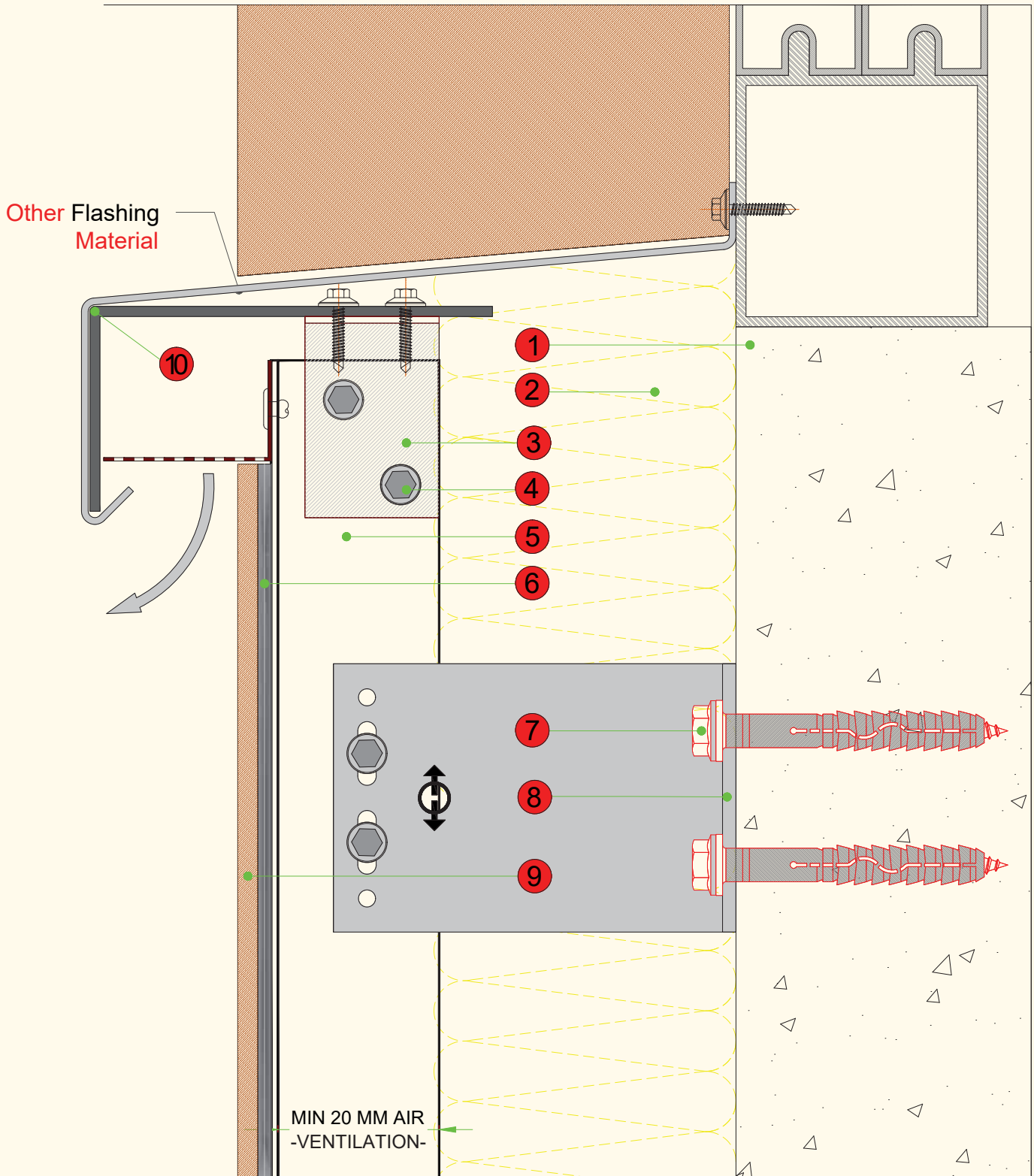

Sl. No.	Accessories	Concealed Fixing 'Adhesive' System	D3 - Window sill
1	EXISTING CONSTRUCTION		
2	INSULATION		
3	L BRACKET/ANGLE		
4	SELF TAPPING SCREW		
5	VERTICAL L PROFILE		
6	DOUBLE SIDED TAPE & SILICONE		
7	ANCHOR FASTENER		
8	ADJUSTABLE L BRACKET		
9	<b>MERINO</b> ARMOUR EWC		
10	FLASHING BY OTHERS		



Sl. No.	Accessories	Concealed Fixing 'Adhesive' System	D4 - Head Details
1	EXISTING CONSTRUCTION		
2	INSULATION		
3	FLASHING BY OTHERS		
4	SELF TAPPING SCREW		
5	L BRACKET/ANGLE		
6	ANCHOR FASTENER		
7	VERTICAL PROFILE		
8	DOUBLE SIDED TAPE & SILICONE		
9	<b>MERINO</b> ARMOUR EWC		
10	ANCHOR FASTENER		
	ADJUSTABLE L BRACKET		

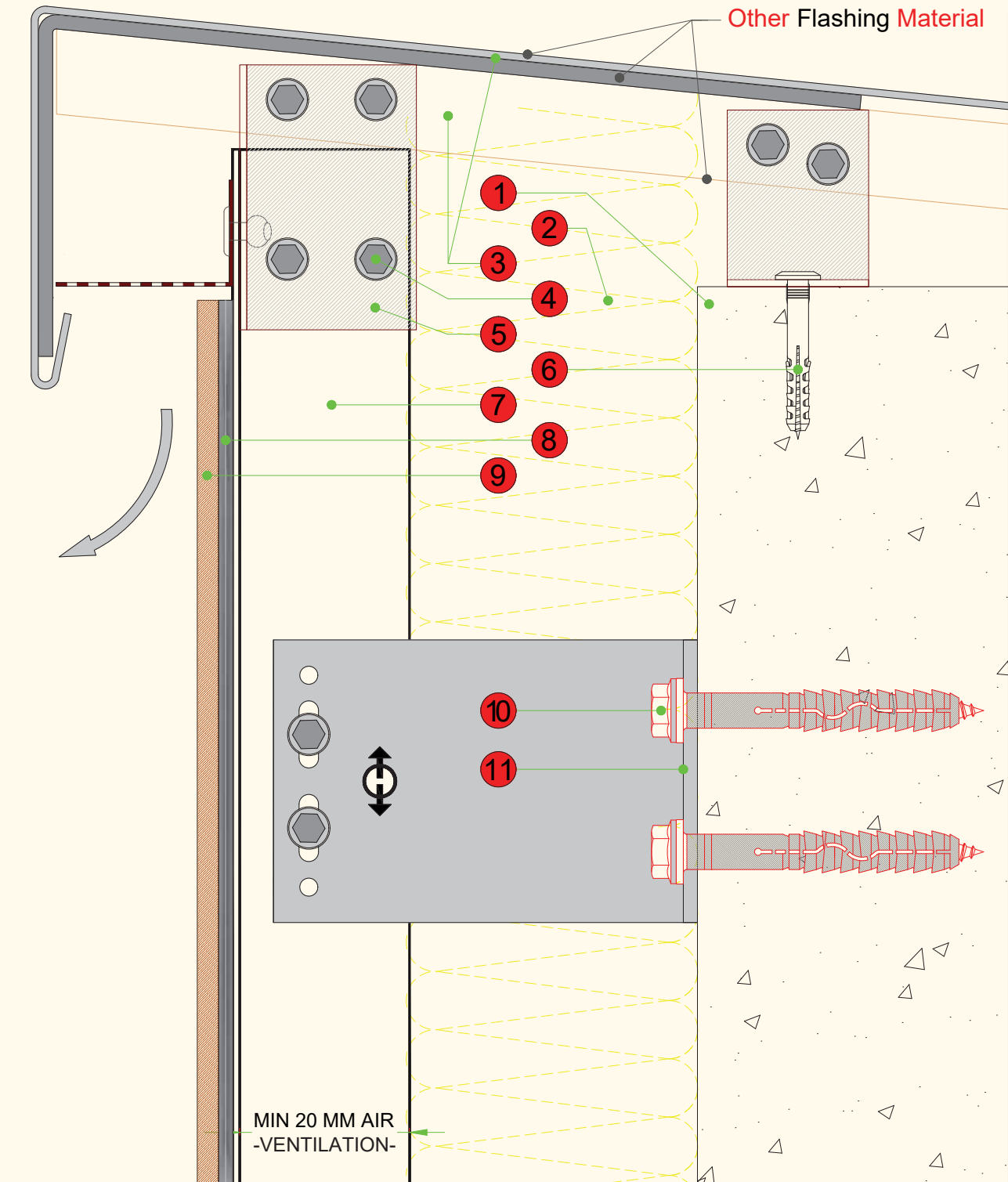

Sl. No.	Accessories	Concealed Fixing 'Adhesive' System	D5 - External Corner
1	EXISTING CONSTRUCTION		
2	INSULATION		
3	ADJUSTABLE L BRACKET		
4	ANCHOR FASTENER		
5	SELF TAPPING SCREW		
6	VERTICAL L PROFILE		
7	DOWSIL 896 SILICONE SEALANT		
8	DOUBLE SIDED ADHESIVE TAPE		
9	<b>MERINO</b> ARMOUR EWC		
10	GAP FOR AIR CIRCULATION		

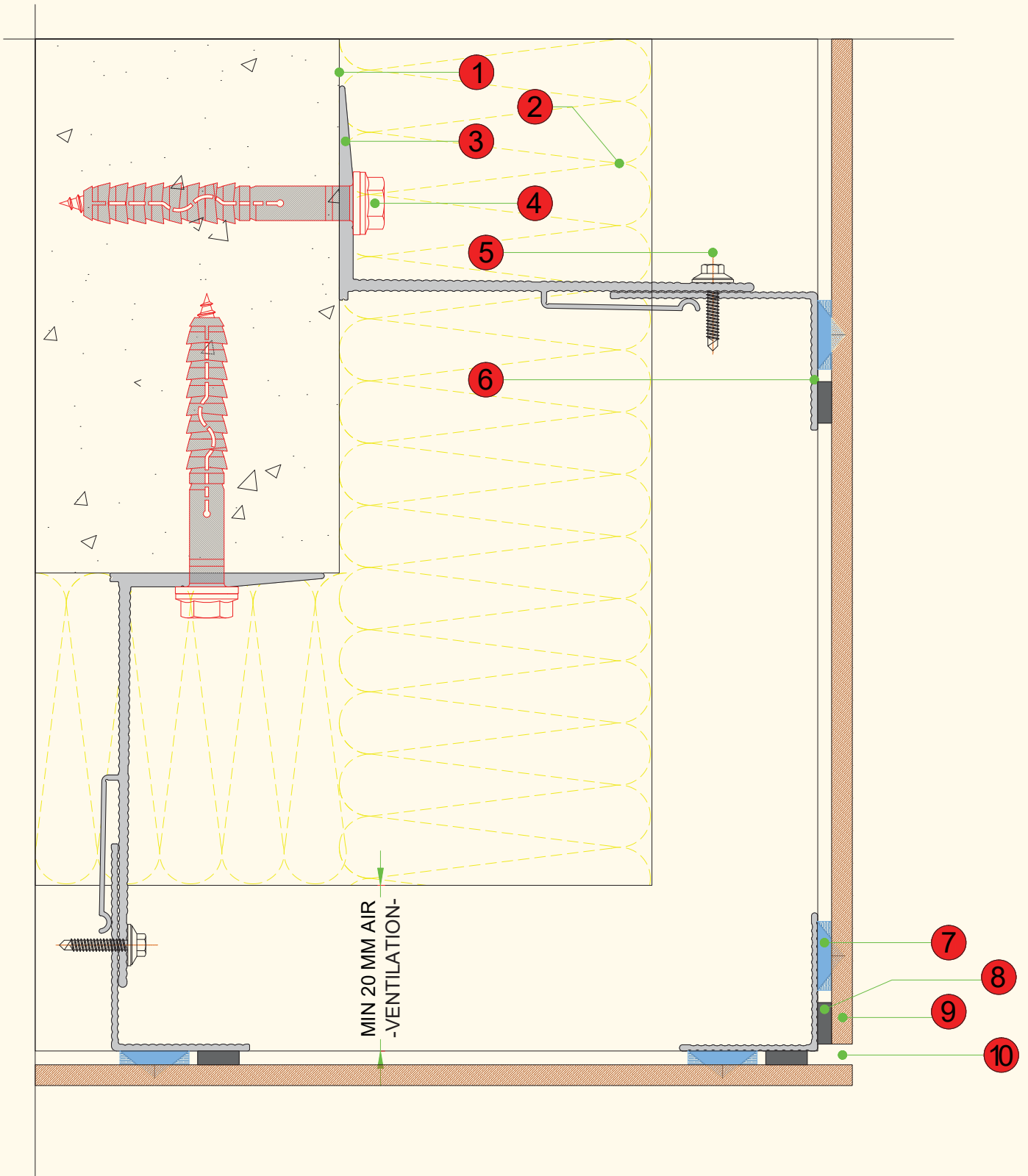



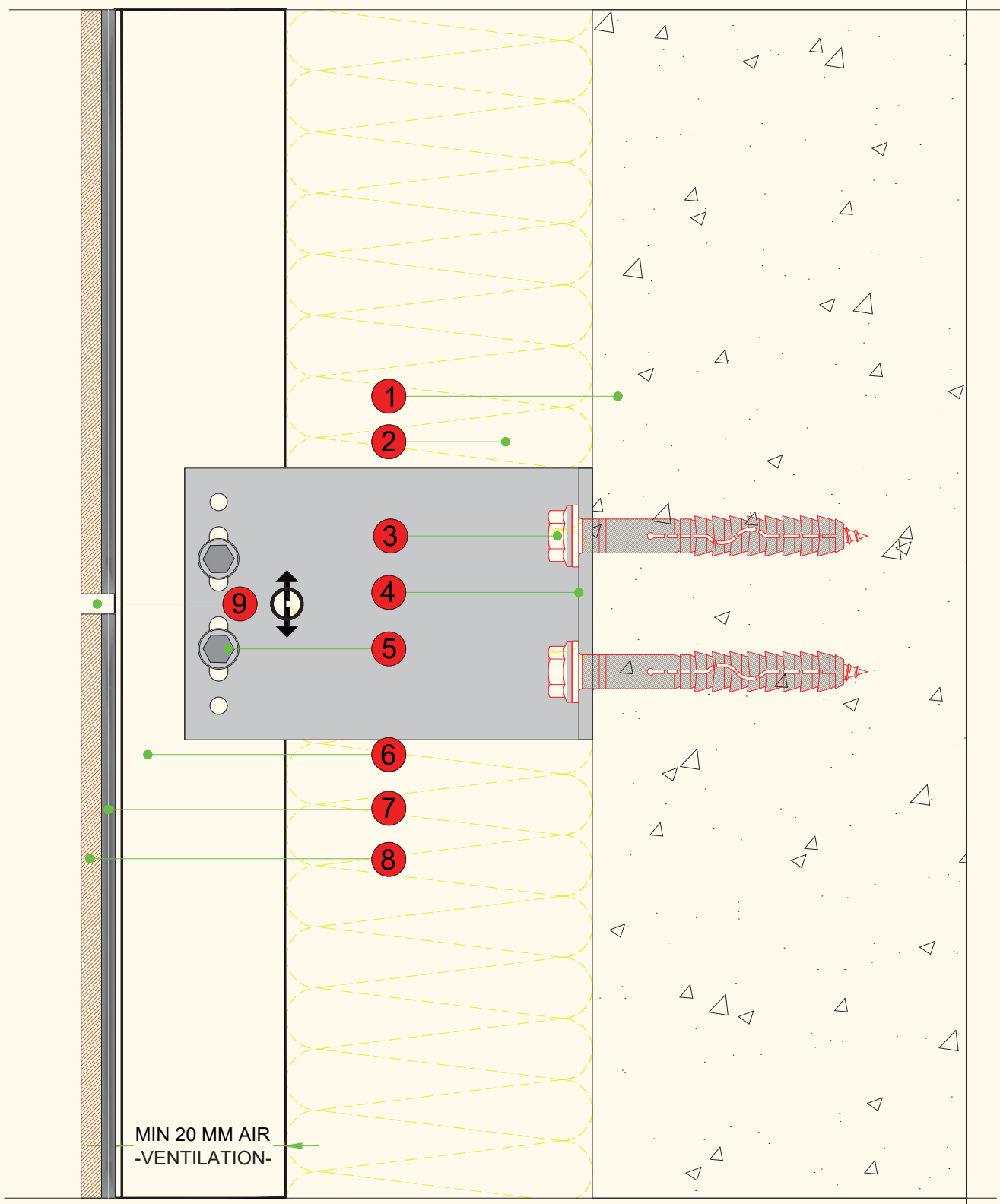

Sl. No.	Accessories	Concealed Fixing 'Adhesive' System	D6 - Vertical section
1	EXISTING CONSTRUCTION		
2	INSULATION		
3	ANCHOR FASTENER		
4	ADJUSTABLE L BRACKET		
5	SELF TAPPING SCREW		
6	VERTICAL L PROFILE		
7	DOUBLE SIDED TAPE & SILICONE		
8	<b>MERINO</b> ARMOUR EWC		
9	GAP FOR AIR CIRCULATION		





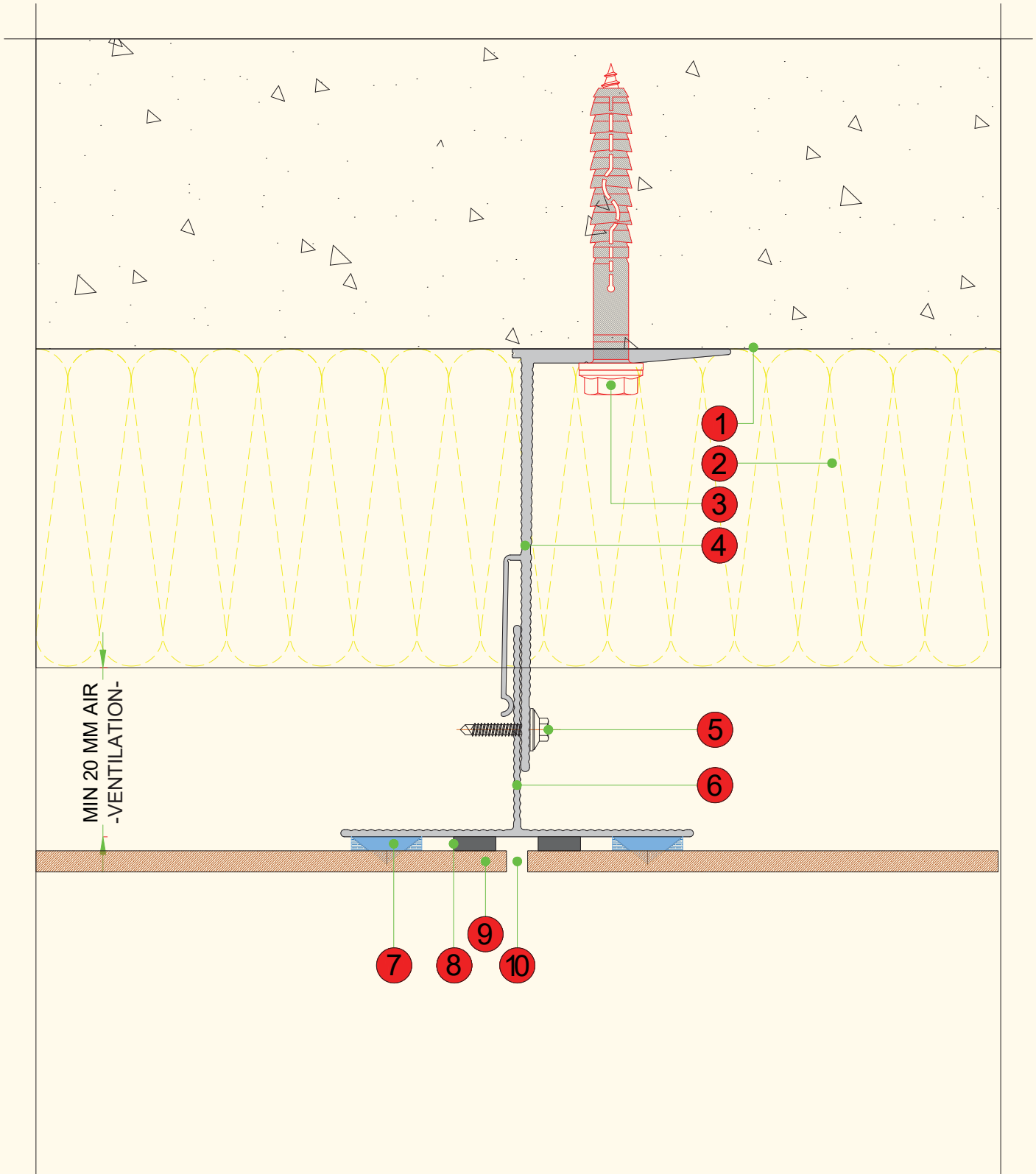

Sl. No.	Accessories	Concealed Fixing 'Adhesive' System	D7 - Horizontal section
1	EXISTING CONSTRUCTION		
2	INSULATION		
3	ANCHOR FASTENER		
4	ADJUSTABLE L BRACKET		
5	SELF TAPPING SCREW		
6	VERTICAL T PROFILE		
7	DOUBLE SIDED ADHESIVE TAPE		
8	DOWSIL 896 SILICONE SEALANT		
9	<b>MERINO</b> ARMOUR EWC		
10	GAP FOR AIR CIRCULATION		

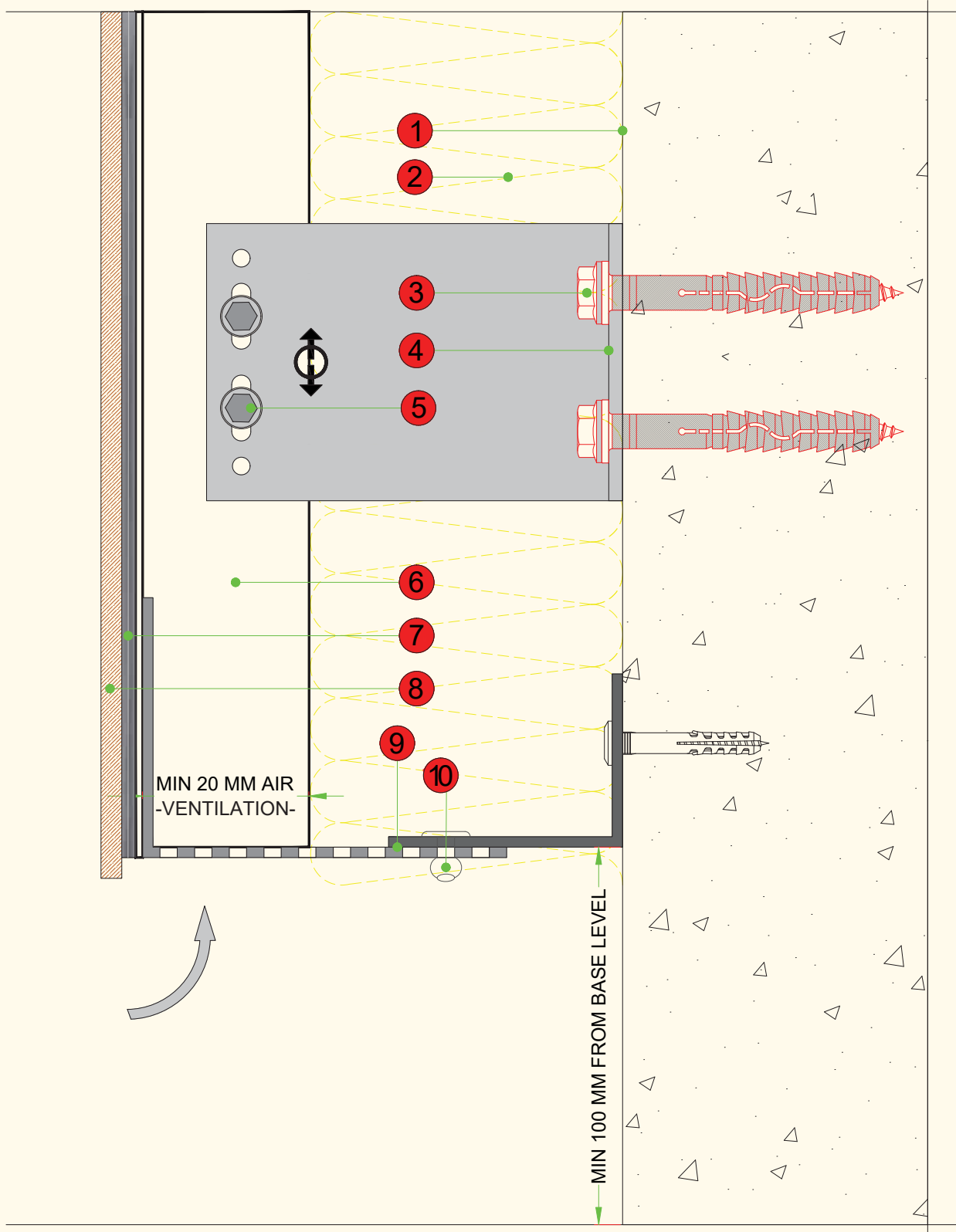

Sl. No.	Accessories	Concealed Fixing 'Adhesive' System	D8 - Base details
1	EXISTING CONSTRUCTION		
2	INSULATION		
3	ANCHOR FASTENER		
4	ADJUSTABLE L BRACKET		
5	SELF TAPPING SCREW		
6	VERTICAL L PROFILE		
7	DOUBLE SIDED TAPE & SILICONE		
8	<b>MERINO</b> ARMOUR EWC		
9	ANCHOR FASTENER		
10	L PROFILE/RAIL		
11	PERFORATED L PROFILE/RAIL		



Sl. No.	Accessories	Concealed Fixing 'Adhesive' System	D9 - Internal Corner
1	EXISTING CONSTRUCTION		
2	INSULATION		
3	ANCHOR FASTENER		
4	ADJUSTABLE L BRACKET		
5	SELF TAPPING SCREW		
6	CORNER L PROFILE		
7	L PROFILE		
8	DOUBLE SIDED ADHESIVE TAPE		
9	DOWSIL 896 SILICONE SEALANT		
10	<b>MERINO</b> ARMOUR EWC		

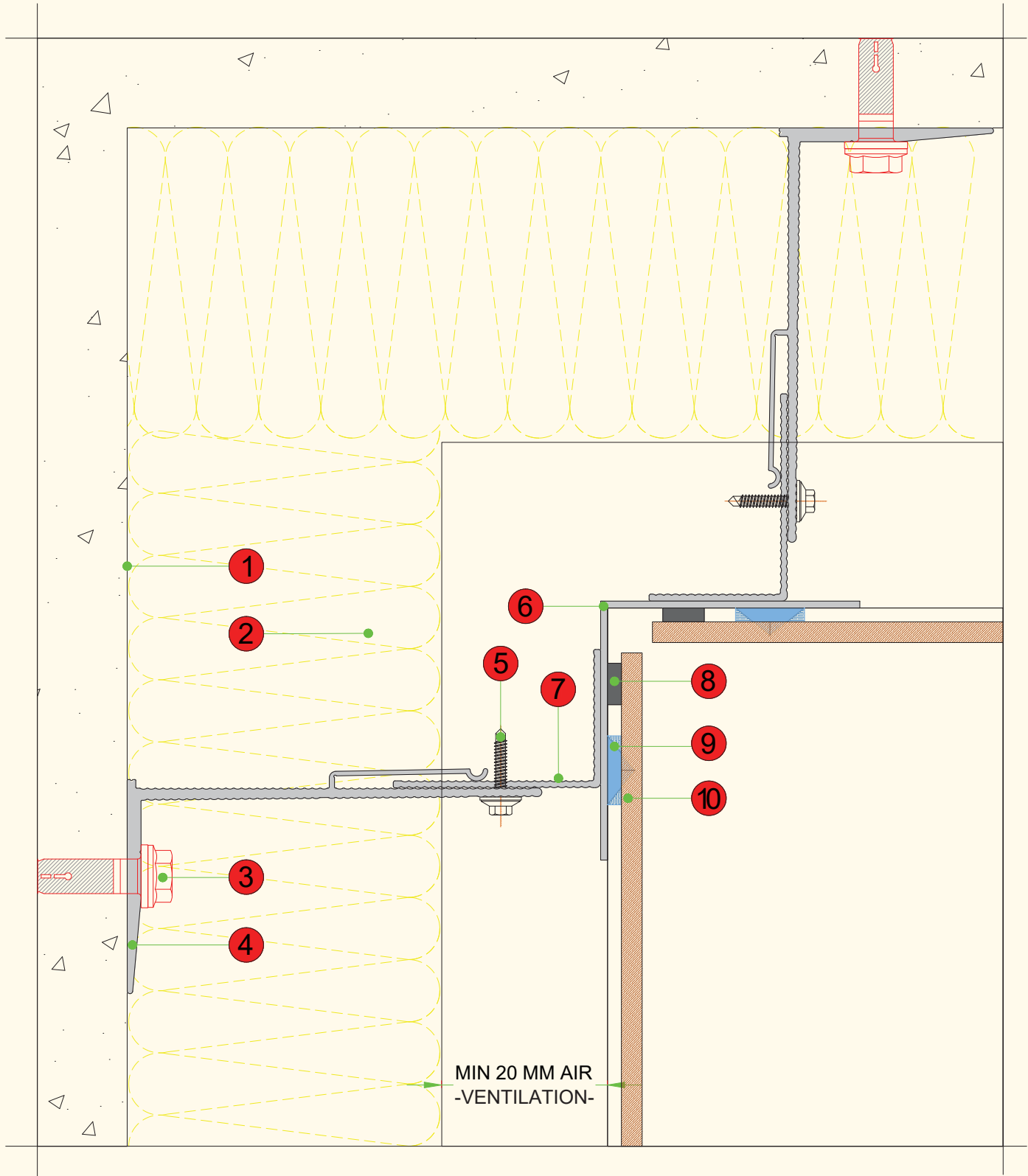

## 2 - CONCEALED FIXING Z CLIP SYSTEM

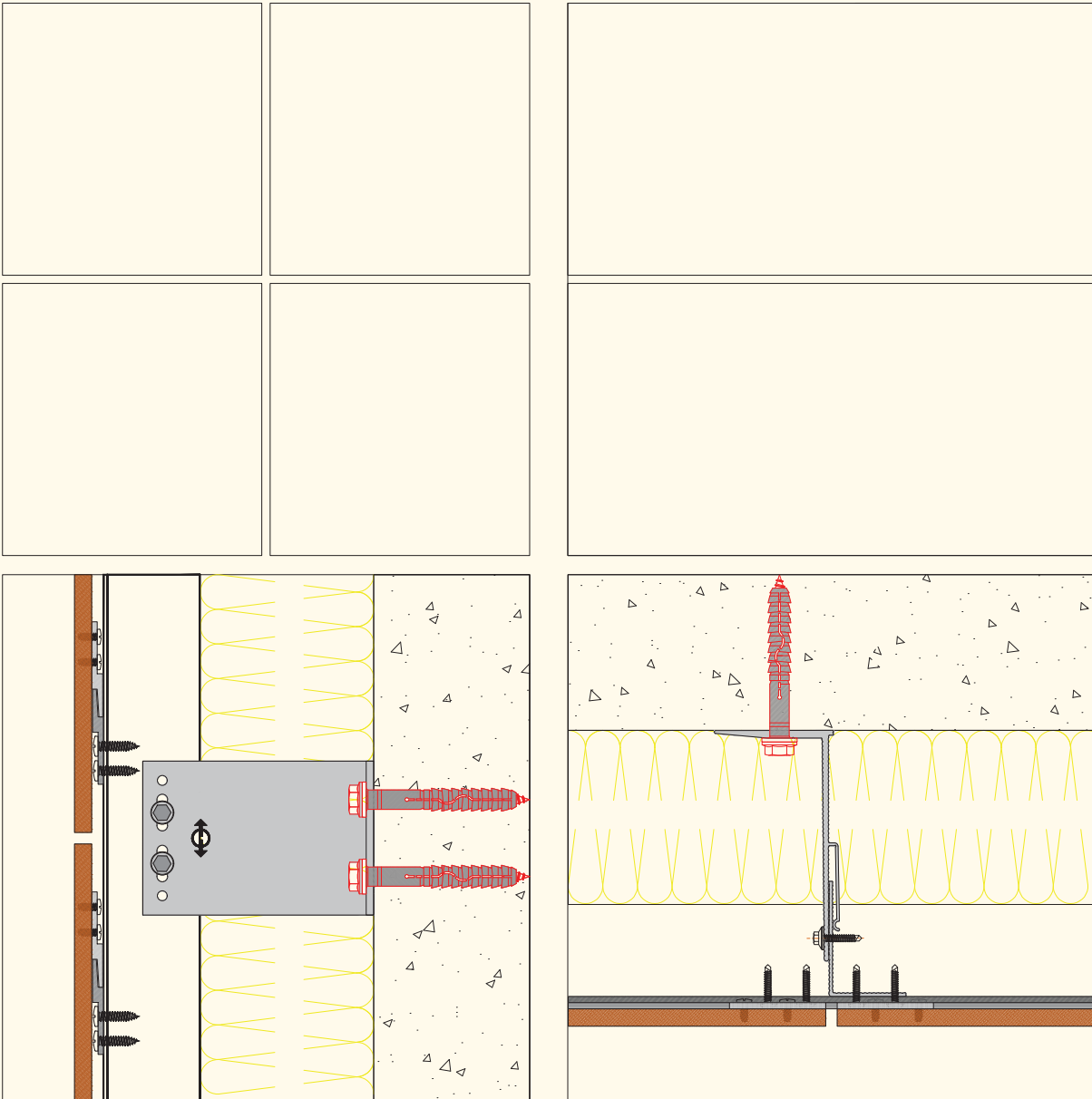





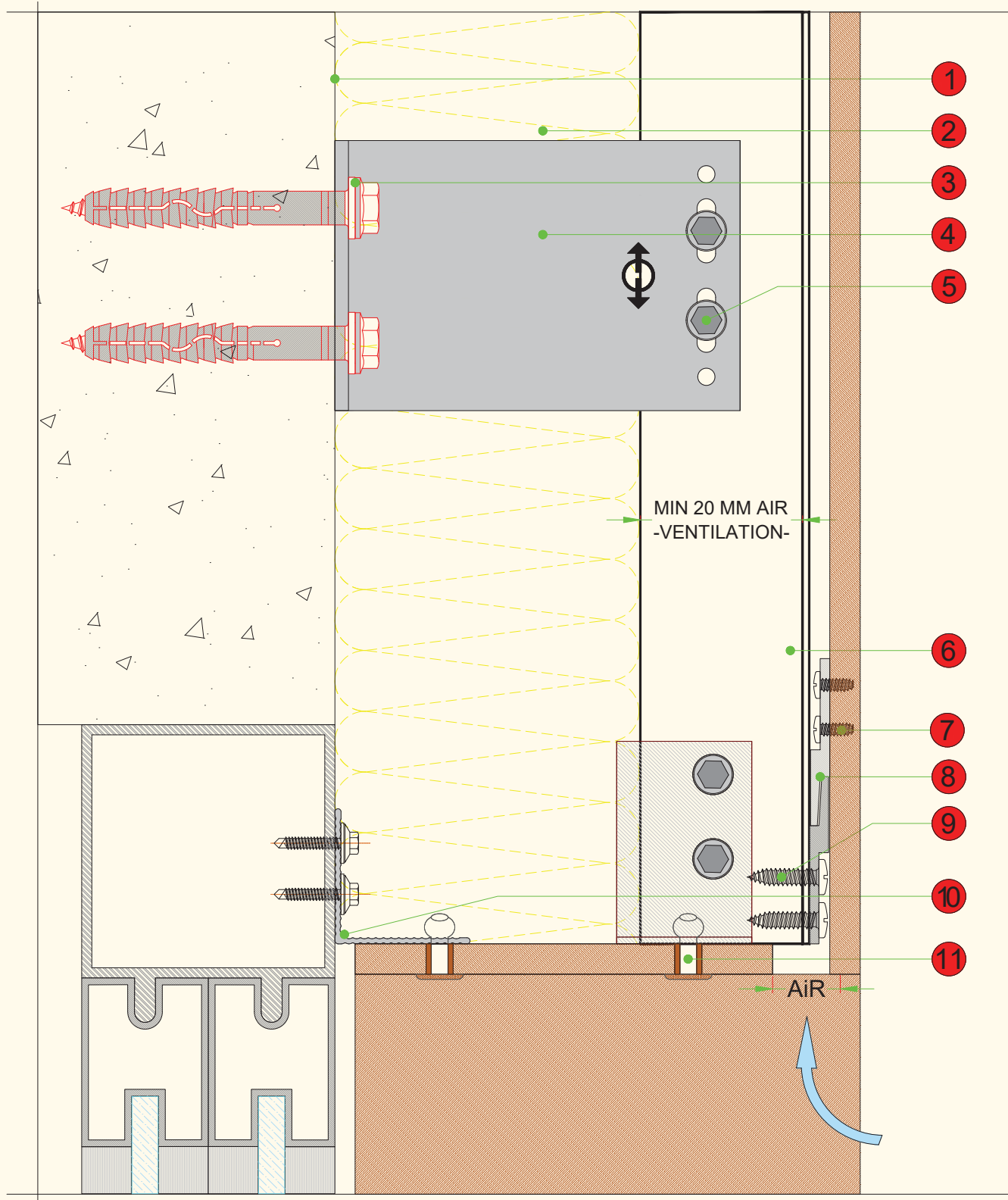

Sl. No.	Accessories	Concealed Fixing 'Z Clip' System	D1 - Window Lintel
1	EXISTING CONSTRUCTION		
2	INSULATION		
3	ANCHOR FASTENER		
4	ADJUSTABLE L BRACKET		
5	SELF TAPPING SCREW		
6	VERTICAL PROFILE		
7	POINTLESS SS SCREW		
8	HORIZONTAL 'Z' PROFILES		
9	SS SCREW		
10	L ANGLE PROFILE		
11	MIN 8 MM <b>MERINO</b> ARMOUR		



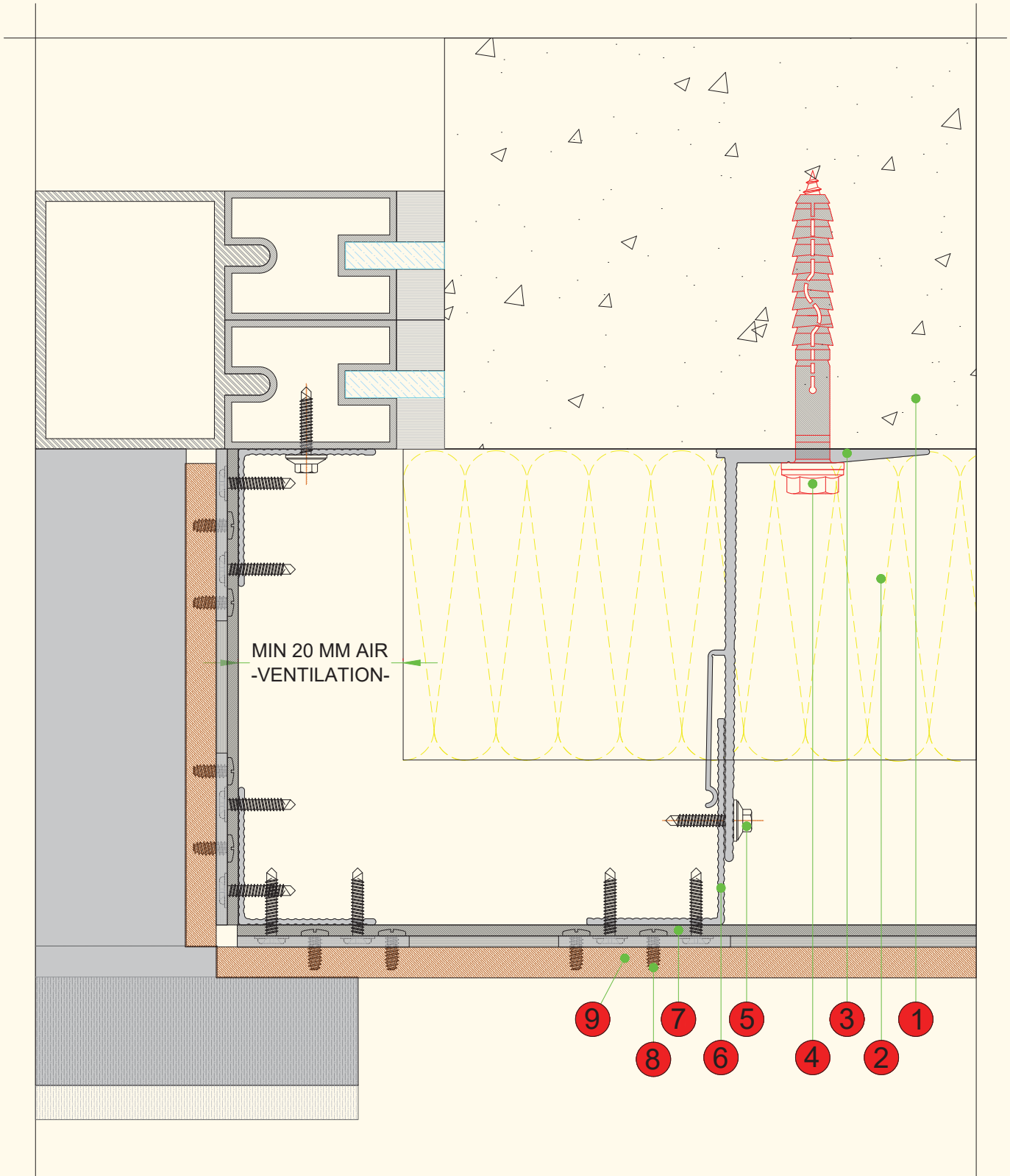

Sl. No.	Accessories	Concealed Fixing 'Z Clip' System	D2 - Window Reveal
1	EXISTING CONSTRUCTION		
2	INSULATION		
3	ADJUSTABLE L BRACKET		
4	ANCHOR FASTENER		
5	SELF TAPPING SCREW		
6	VERTICAL PROFILE		
7	HORIZONTAL 'Z' PROFILES		
8	POINTLESS SS SCREW		
9	MIN 8 MM <b>MERINO</b> ARMOUR		



Sl. No.	Accessories	Concealed Fixing 'Z Clip' System	D3 - Window sill
1	EXISTING CONSTRUCTION		
2	INSULATION		
3	ANCHOR FASTENER		
4	ADJUSTABLE L BRACKET		
5	SELF TAPPING SCREW		
6	VERTICAL PROFILE		
7	POINTLESS SS SCREW		
8	MIN 8 MM <b>MERINO</b> ARMOUR		
9	HORIZONTAL 'Z' PROFILE		
10	SS SCREW		

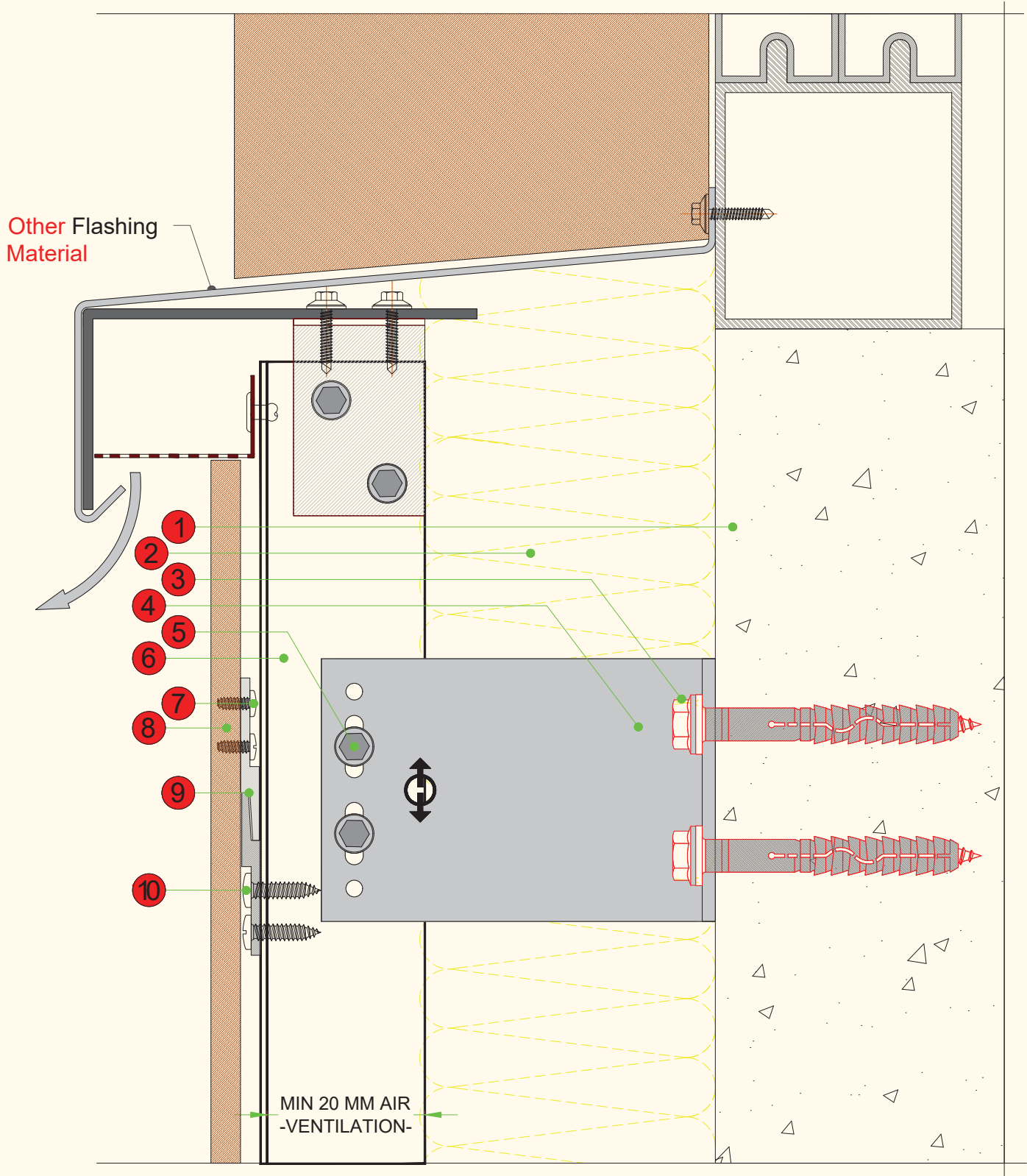

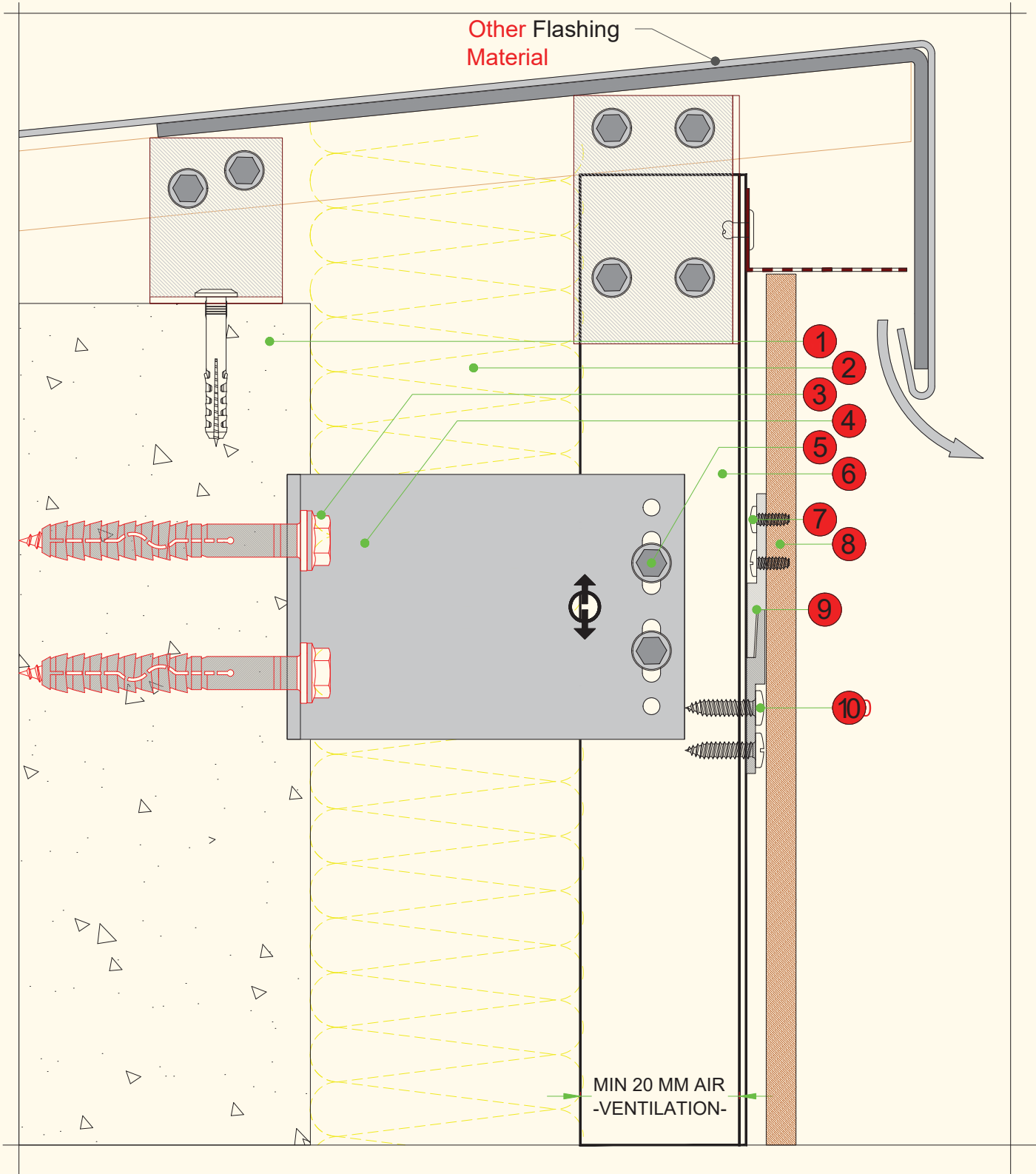

Sl. No.	Accessories	Concealed Fixing 'Z Clip' System	D4 - Head Details
1	EXISTING CONSTRUCTION		
2	INSULATION		
3	ANCHOR FASTENER		
4	ADJUSTABLE L BRACKET		
5	SELF TAPPING SCREW		
6	VERTICAL PROFILE		
7	POINTLESS SS SCREW		
8	MIN 8 MM <b>MERINO</b> ARMOUR		
9	HORIZONTAL 'Z' PROFILE		
10	SS SCREW		





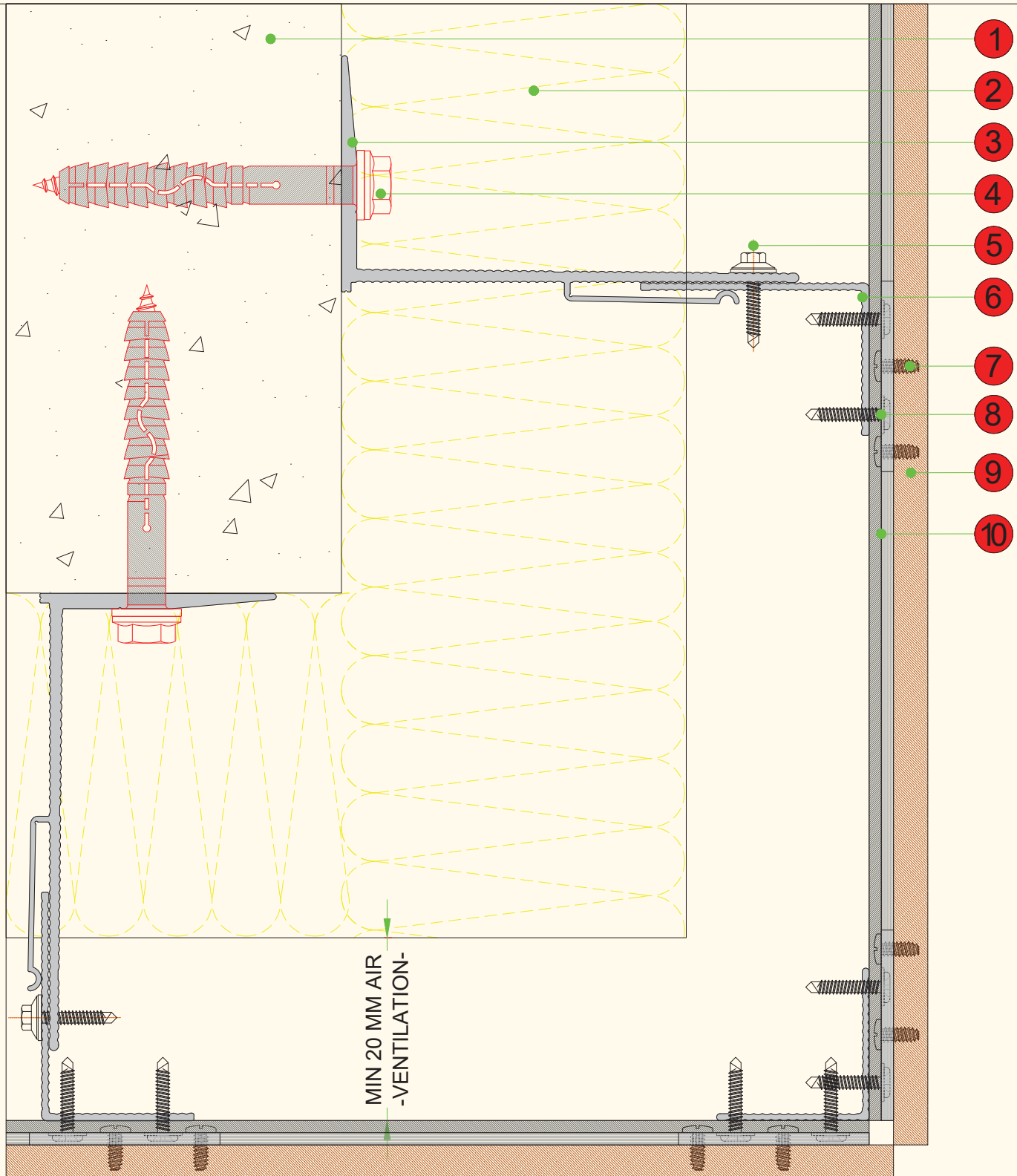

Sl. No.	Accessories	Concealed Fixing 'Z Clip' System	D5 - External Corner
1	EXISTING CONSTRUCTION		
2	INSULATION		
3	ANCHOR FASTENER		
4	ADJUSTABLE L BRACKET		
5	SELF TAPPING SCREW		
6	VERTICAL PROFILE		
7	POINTLESS SS SCREW		
8	SS SCREW		
9	MIN 8 MM <b>MERINO</b> ARMOUR		
10	HORIZONTAL 'Z' PROFILE		



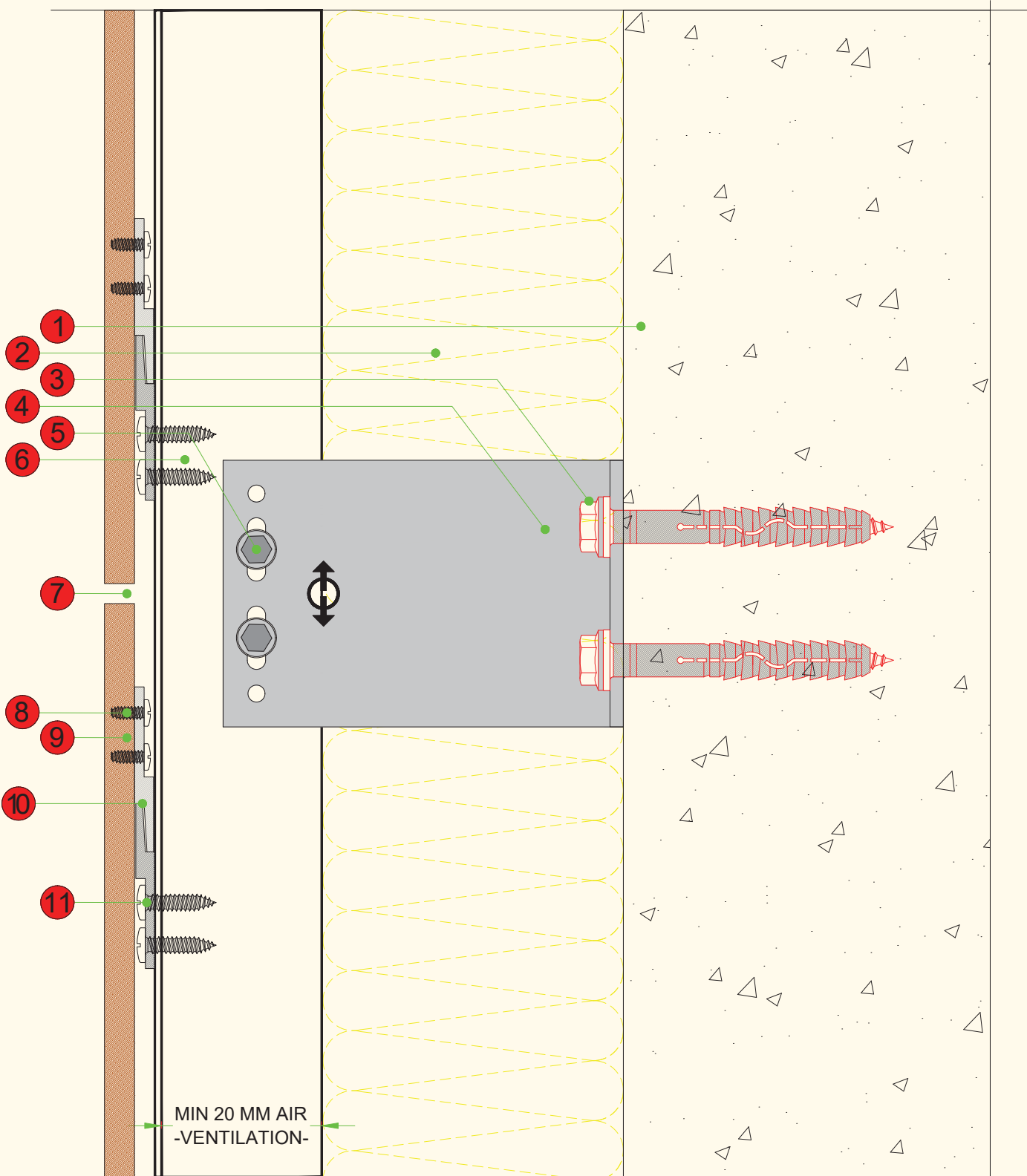

Sl. No.	Accessories	Concealed Fixing 'Z Clip' System	D6 - Vertical section
1	EXISTING CONSTRUCTION		
2	INSULATION		
3	ANCHOR FASTENER		
4	ADJUSTABLE L BRACKET		
5	SELF TAPPING SCREW		
6	VERTICAL PROFILE		
7	MIN 6MM GROOVE/GAP		
8	POINTLESS SS SCREW		
9	MIN 8 MM <b>MERINO</b> ARMOUR		
10	HORIZONTAL 'Z' PROFILE		
11	SS SCREW		



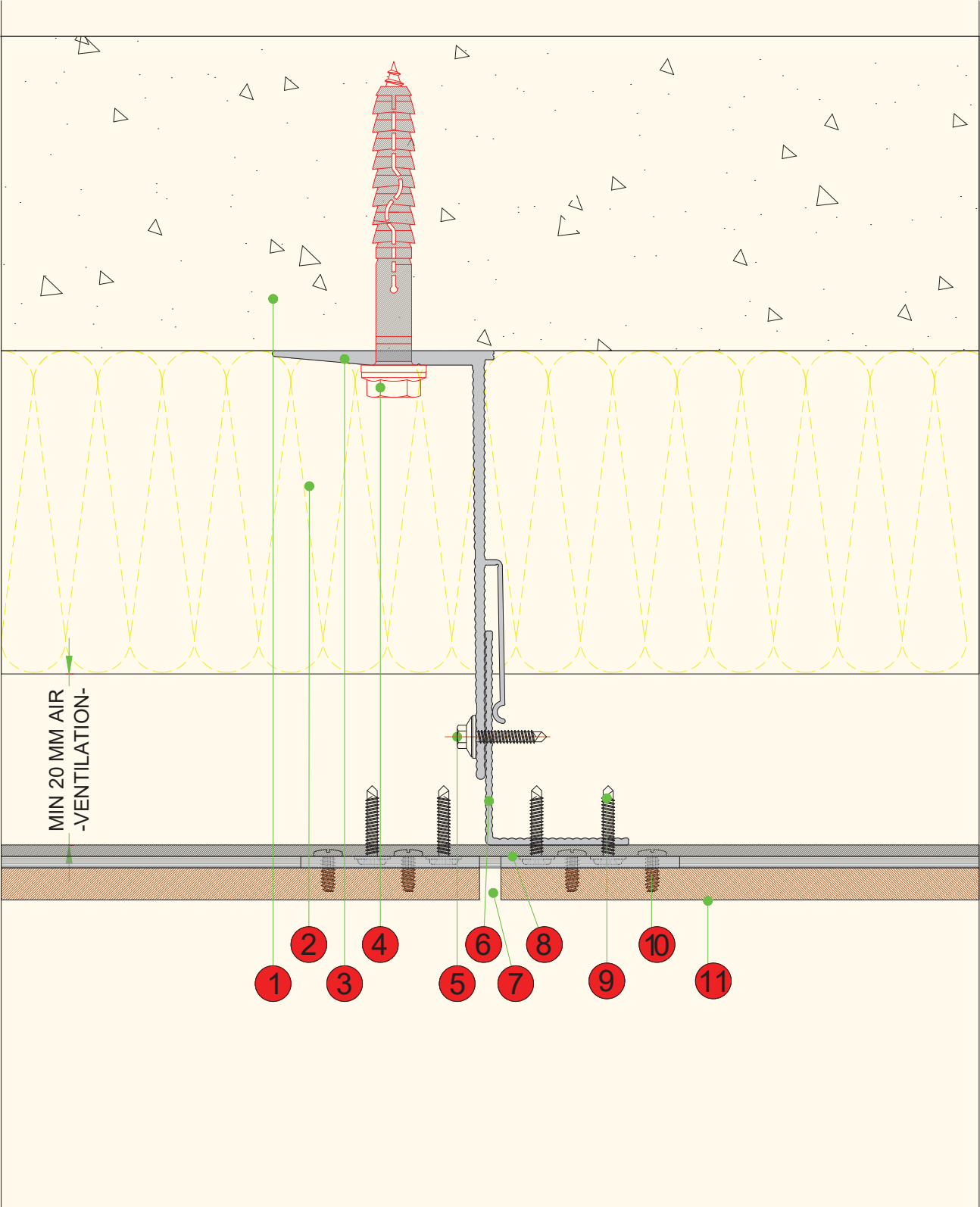

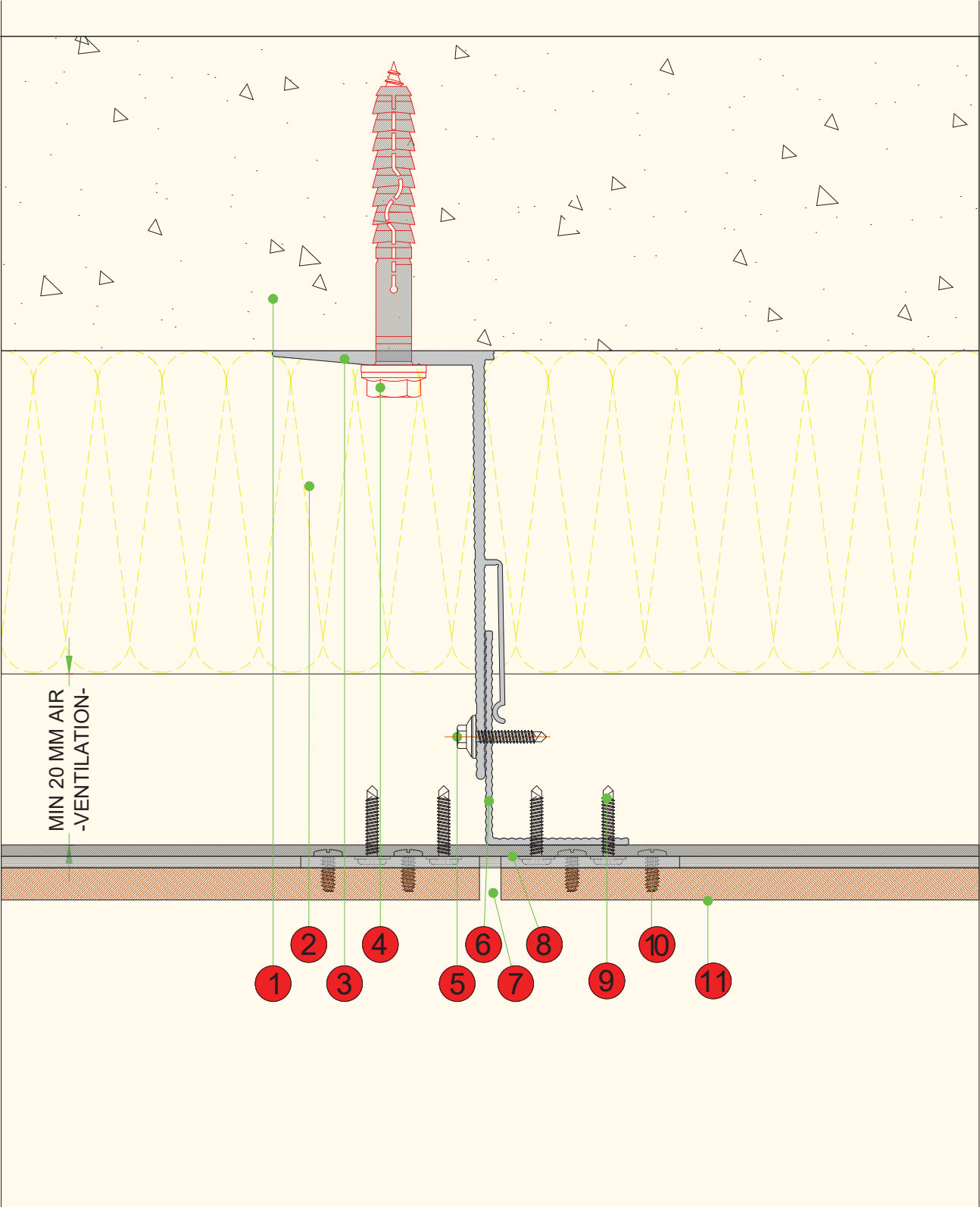

Sl. No.	Accessories	Concealed Fixing 'Z Clip' System	D7 - Horizontal section
1	EXISTING CONSTRUCTION		
2	INSULATION		
3	ANCHOR FASTENER		
4	ADJUSTABLE L BRACKET		
5	SELF TAPPING SCREW		
6	VERTICAL PROFILE		
7	MIN 6MM GROOVE/GAP		
8	HORIZONTAL 'Z' PROFILE		
9	SS SCREW		
10	POINTLESS SS SCREW		
11	MIN 8 MM <b>MERINO</b> ARMOUR		

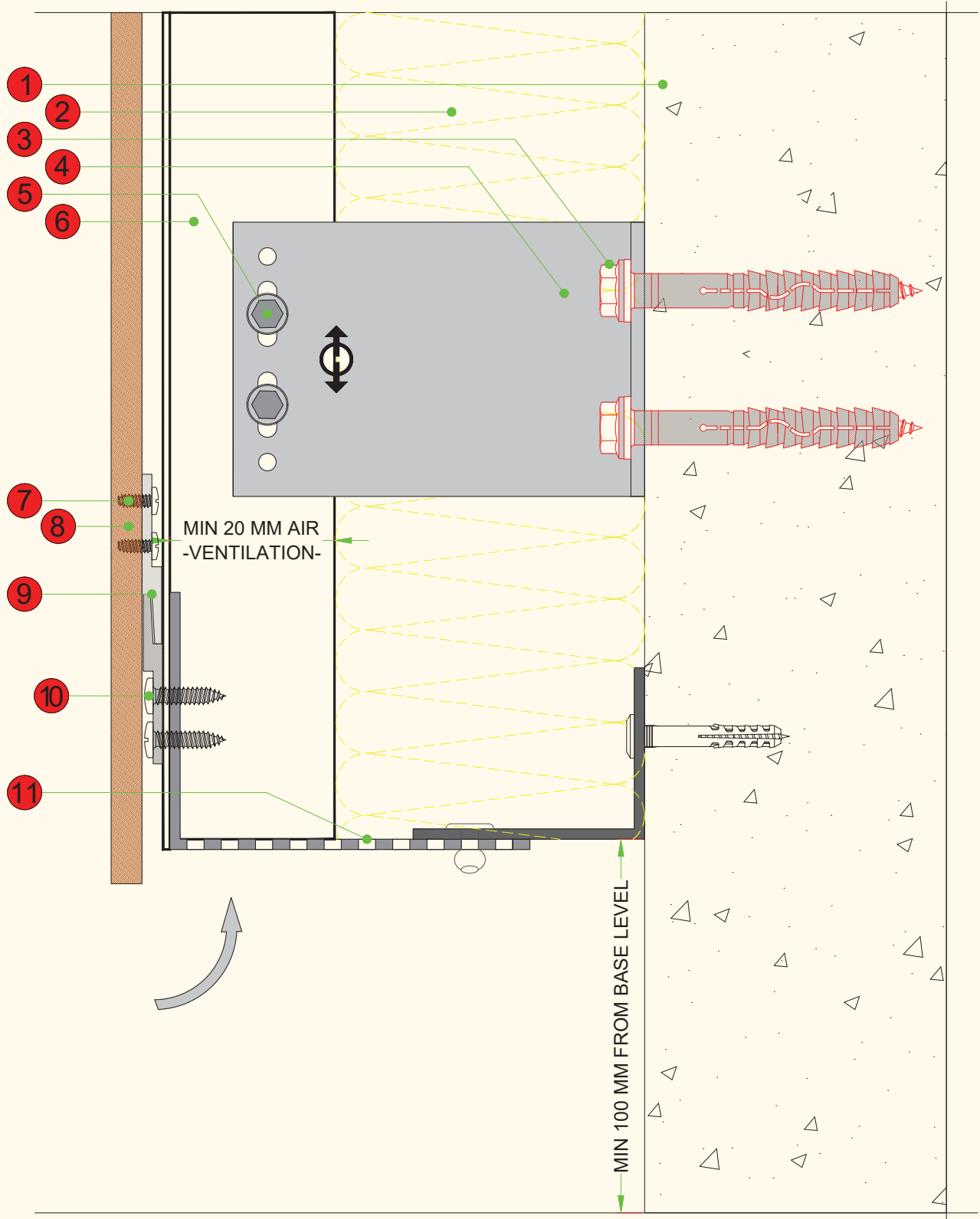

Sl. No.	Accessories	Concealed Fixing 'Z Clip' System	D8 - Base details
1	EXISTING CONSTRUCTION		
2	INSULATION		
3	ANCHOR FASTENER		
4	ADJUSTABLE L BRACKET		
5	SELF TAPPING SCREW		
6	VERTICAL PROFILE		
7	POINTLESS SS SCREW		
8	MIN 8 MM <b>MERINO</b> ARMOUR		
9	HORIZONTAL 'Z' PROFILE		
10	SS SCREW		
11	PERFORATED L PROFILE		



Sl. No.	Accessories	Concealed Fixing 'Z Clip' System	D9 - Internal Corner
1	EXISTING CONSTRUCTION		
2	INSULATION		
3	ANCHOR FASTENER		
4	ADJUSTABLE L BRACKET		
5	SELF TAPPING SCREW		
6	VERTICAL PROFILE		
7	HORIZONTAL 'Z' PROFILE		
8	POINTLESS SS SCREW		
9	SS SCREW		
10	MIN 8 MM <b>MERINO</b> ARMOUR		

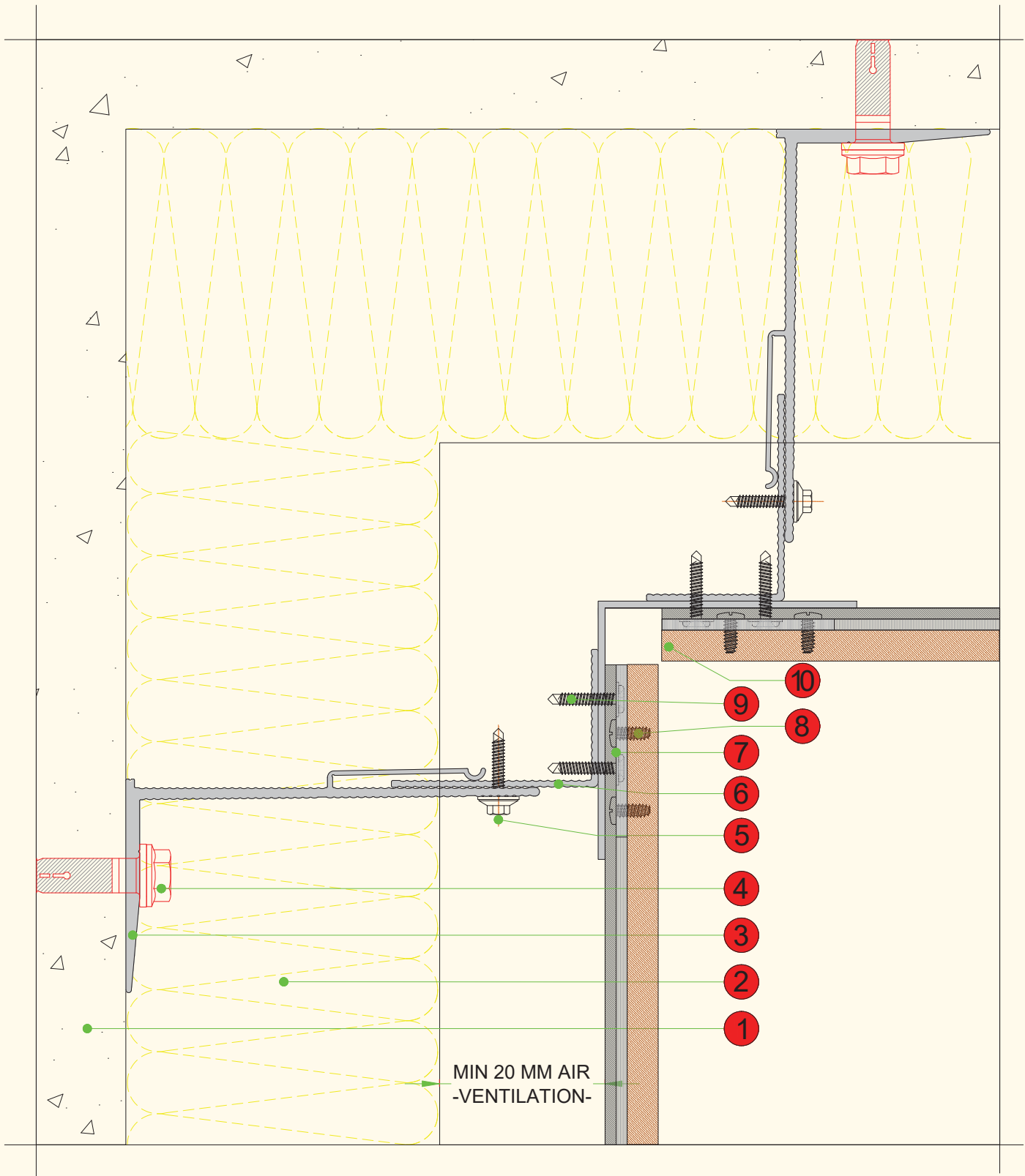

### 3 - CONCEALED FIXING J CLIP SYSTEM

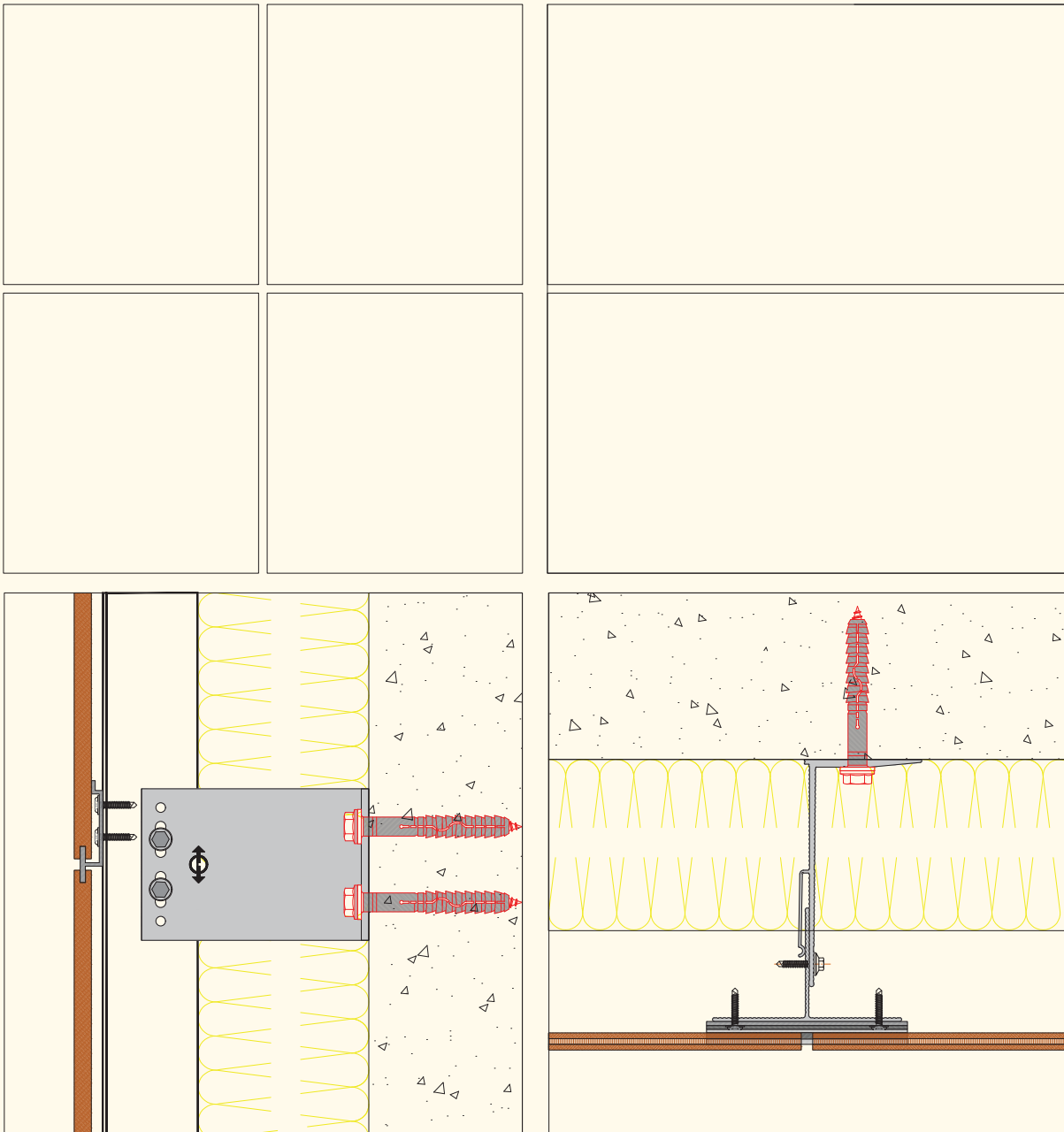



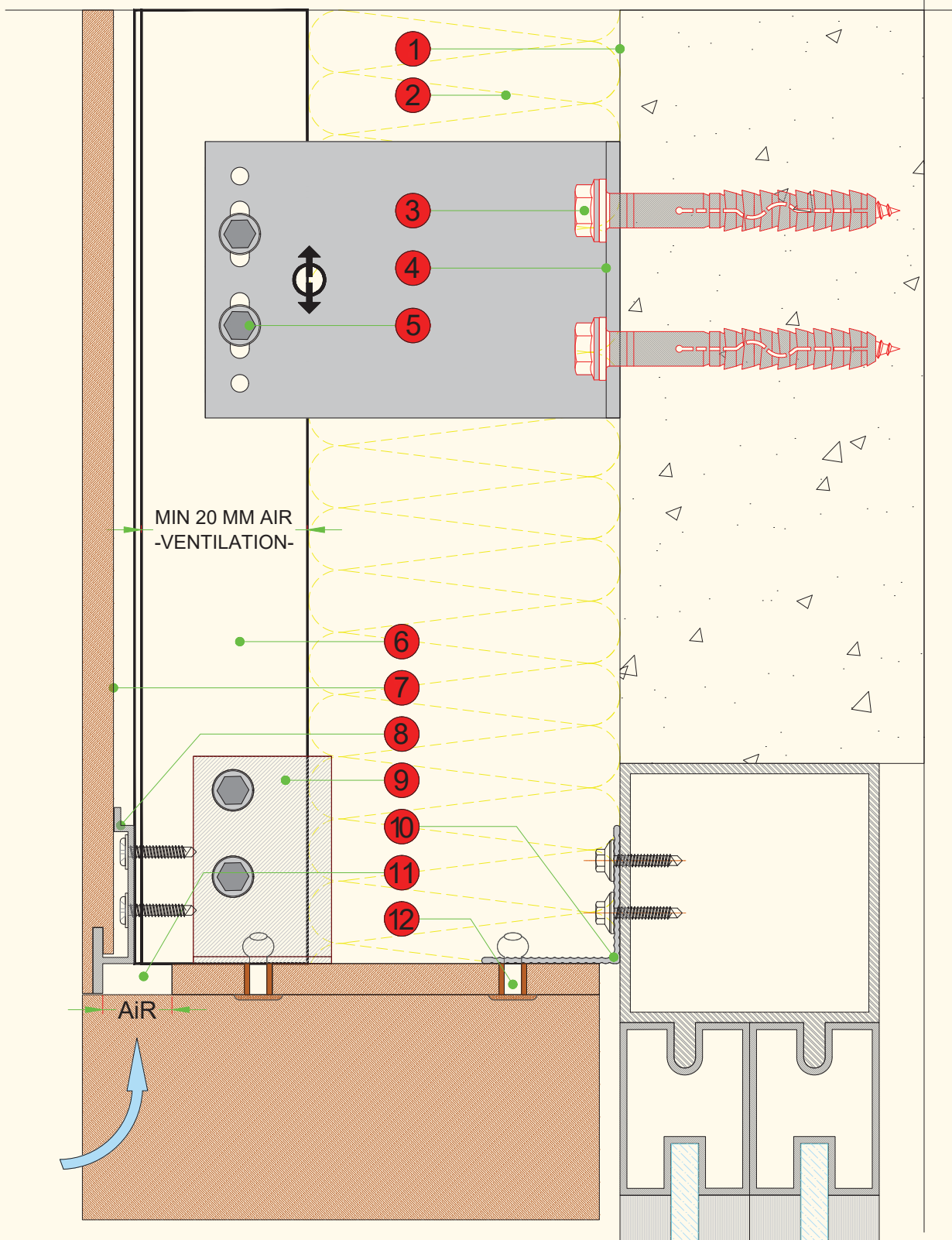

Sl. No.	Accessories	Concealed Fixing 'J Clip' System	D1 - Window Lintel
1	EXISTING CONSTRUCTION		
2	INSULATION		
3	ANCHOR FASTENER		
4	ADJUSTABLE L BRACKET		
5	SELF TAPPING SCREW		
6	VERTICAL PROFILE		
7	<b>MERINO</b> ARMOUR EWC		
8	HORIZONTAL 'J' PROFILE		
9 - 10	L BRACKET / ANGLE		
11	AIR GAP FOR VENTILATION		
12	<b>MERINO</b> POP BLIND RIVET		





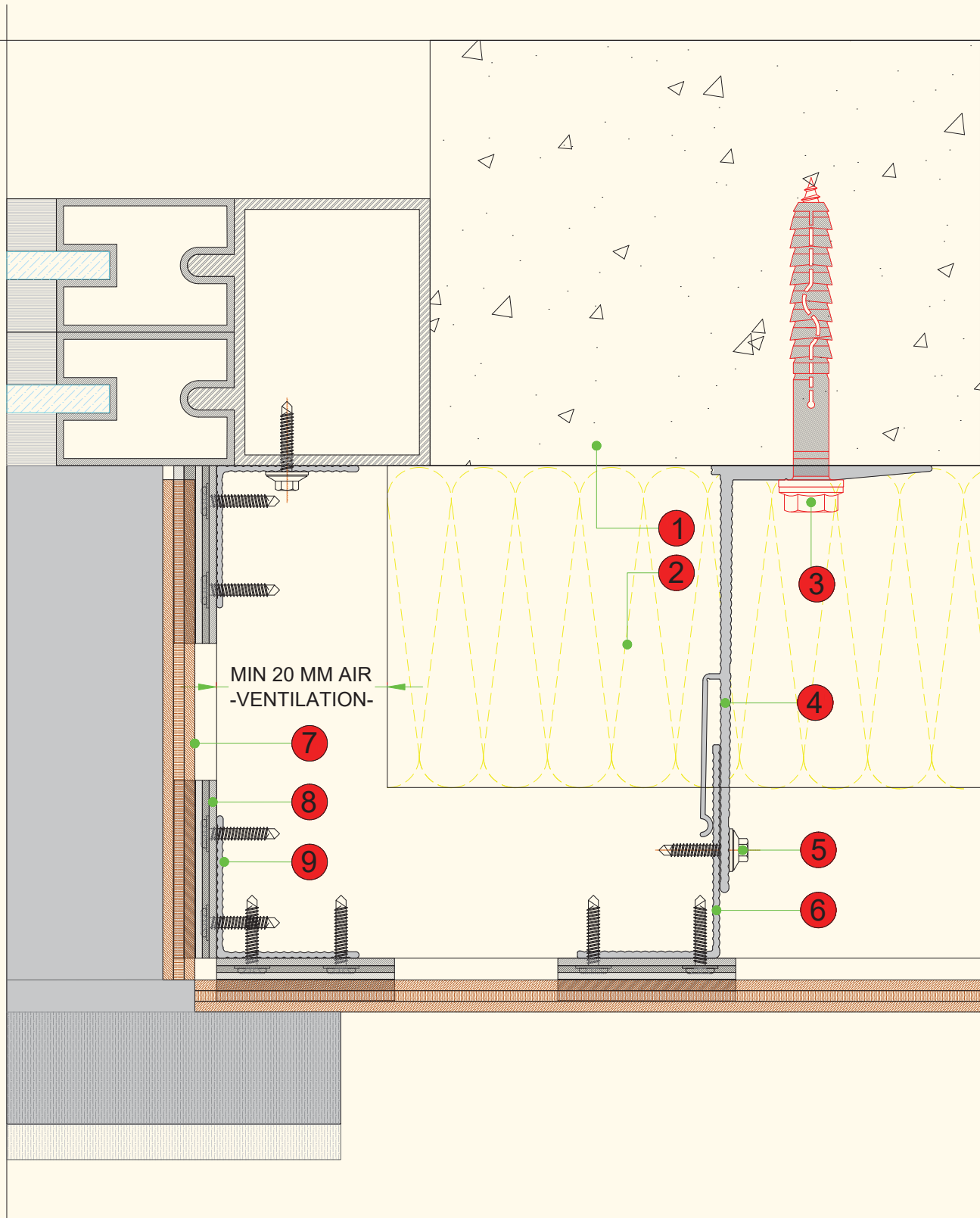

Sl. No.	Accessories	Concealed Fixing 'J Clip' System	D2 - Window Reveal
1	EXISTING CONSTRUCTION		
2	INSULATION		
3	ANCHOR FASTENER		
4	ADJUSTABLE L BRACKET		
5	SELF TAPPING SCREW		
6	VERTICAL L PROFILE		
7	<b>MERINO</b> ARMOUR EWC		
8	HORIZONTAL 'J' PROFILE		
9	L PROFILE		

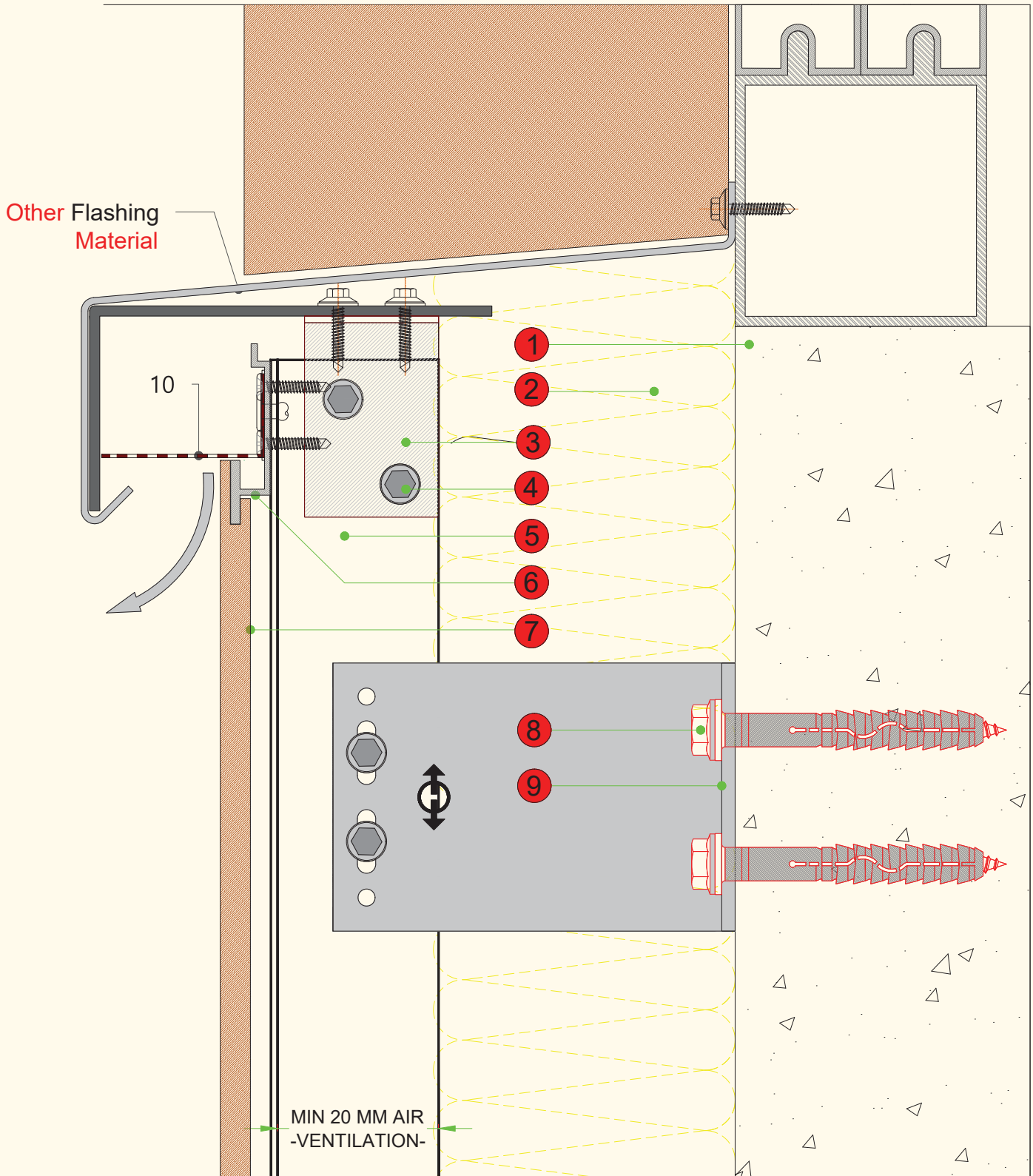

Sl. No.	Accessories	Concealed Fixing 'J Clip' System	D3 - Window sill
1	EXISTING CONSTRUCTION		
2	INSULATION		
3	L BRACKET/ANGLE		
4	SELF TAPPING SCREW		
5	VERTICAL L PROFILE		
6	HORIZONTAL 'J' PROFILE		
7	<b>MERINO</b> ARMOUR EWC		
8	ANCHOR FASTENER		
9	ADJUSTABLE L BRACKET		



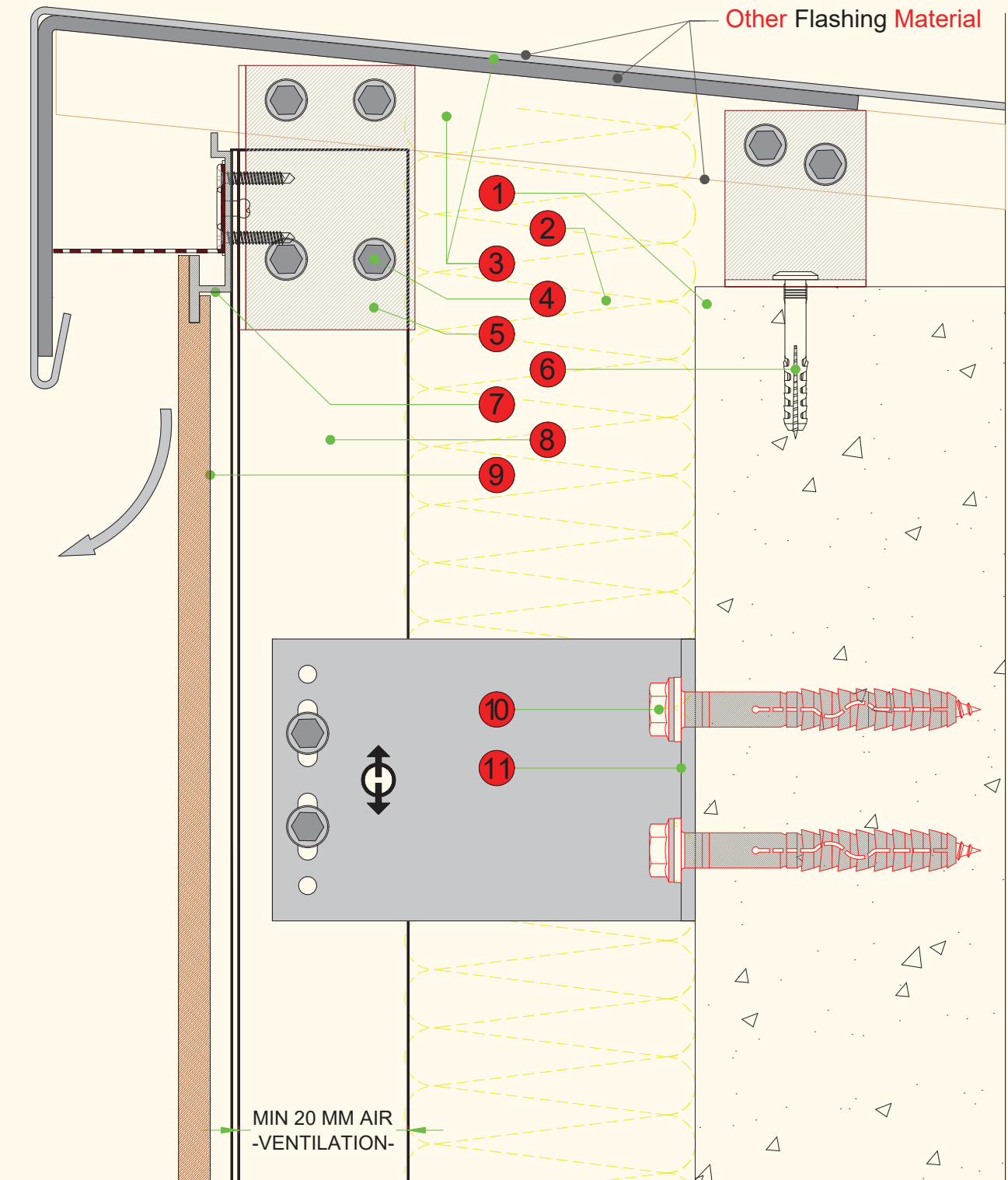

Sl. No.	Accessories	Concealed Fixing 'J Clip' System	D4 - Head Details
1	EXISTING CONSTRUCTION		
2	INSULATION		
3	FLASHING BY OTHERS		
4	SELF TAPPING SCREW		
5	L BRACKET / ANGLE		
6	ANCHOR FASTENER		
7	HORIZONTAL 'J' PROFILE		
8	VERTICAL PROFILE		
9	<b>MERINO</b> ARMOUR EWC		
10	ANCHOR FASTENER		
11	ADJUSTABLE L BRACKET		





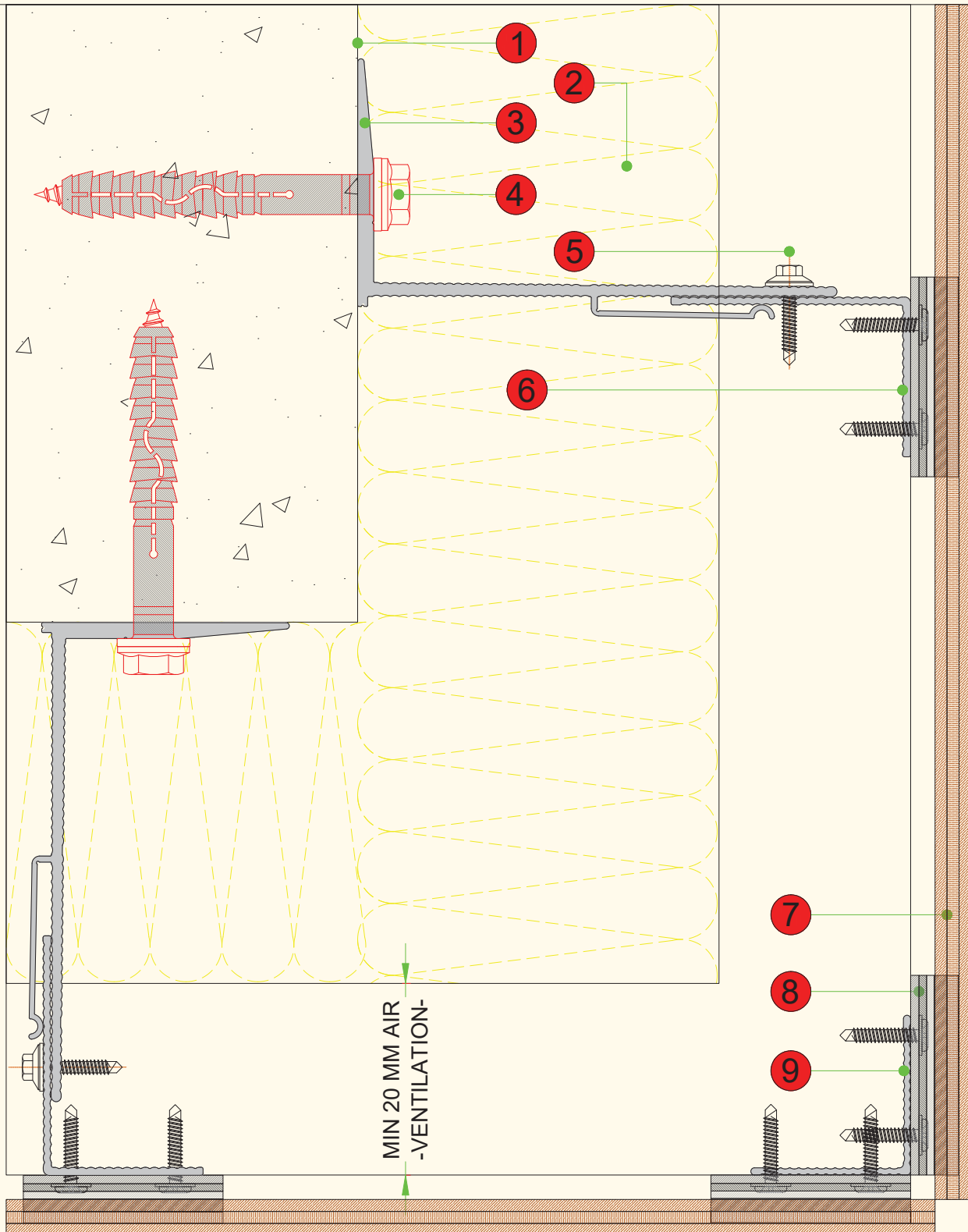

Sl. No.	Accessories	Concealed Fixing 'J Clip' System	D5 - External Corner
1	EXISTING CONSTRUCTION		
2	INSULATION		
3	ADJUSTABLE L BRACKET		
4	ANCHOR FASTENER		
5	SELF TAPPING SCREW		
6	VERTICAL L PROFILE		
7	<b>MERINO</b> ARMOUR EWC		
8	HORIZONTAL 'J' PROFILE		
9	L PROFILE		



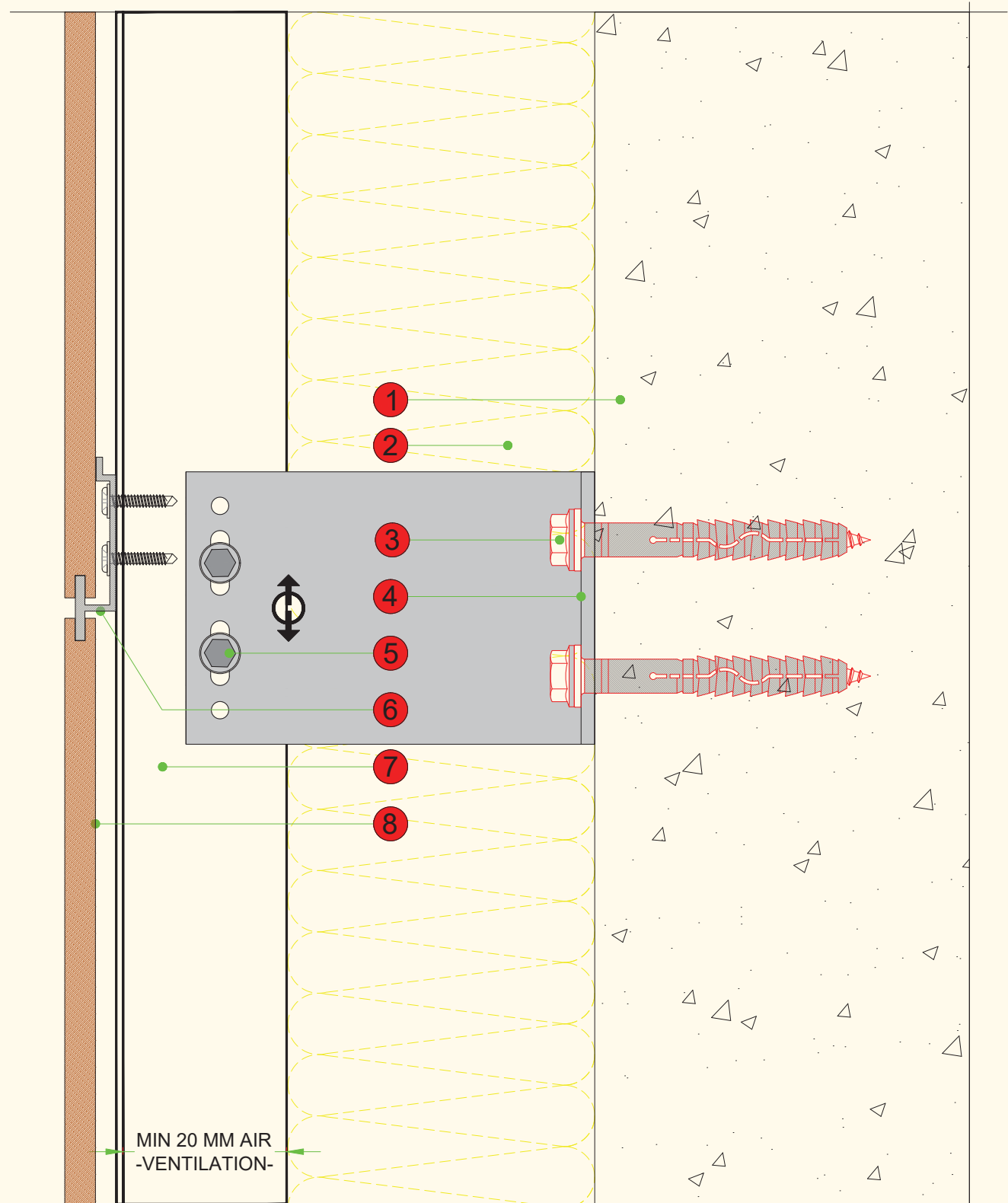

Sl. No.	Accessories	Concealed Fixing 'J Clip' System	D6 - Vertical section
1	EXISTING CONSTRUCTION		
2	INSULATION		
3	ANCHOR FASTENER		
4	ADJUSTABLE L BRACKET		
5	SELF TAPPING SCREW		
6	HORIZONTAL 'J' PROFILE		
7	VERTICAL L PROFILE		
8	<b>MERINO</b> ARMOUR EWC		





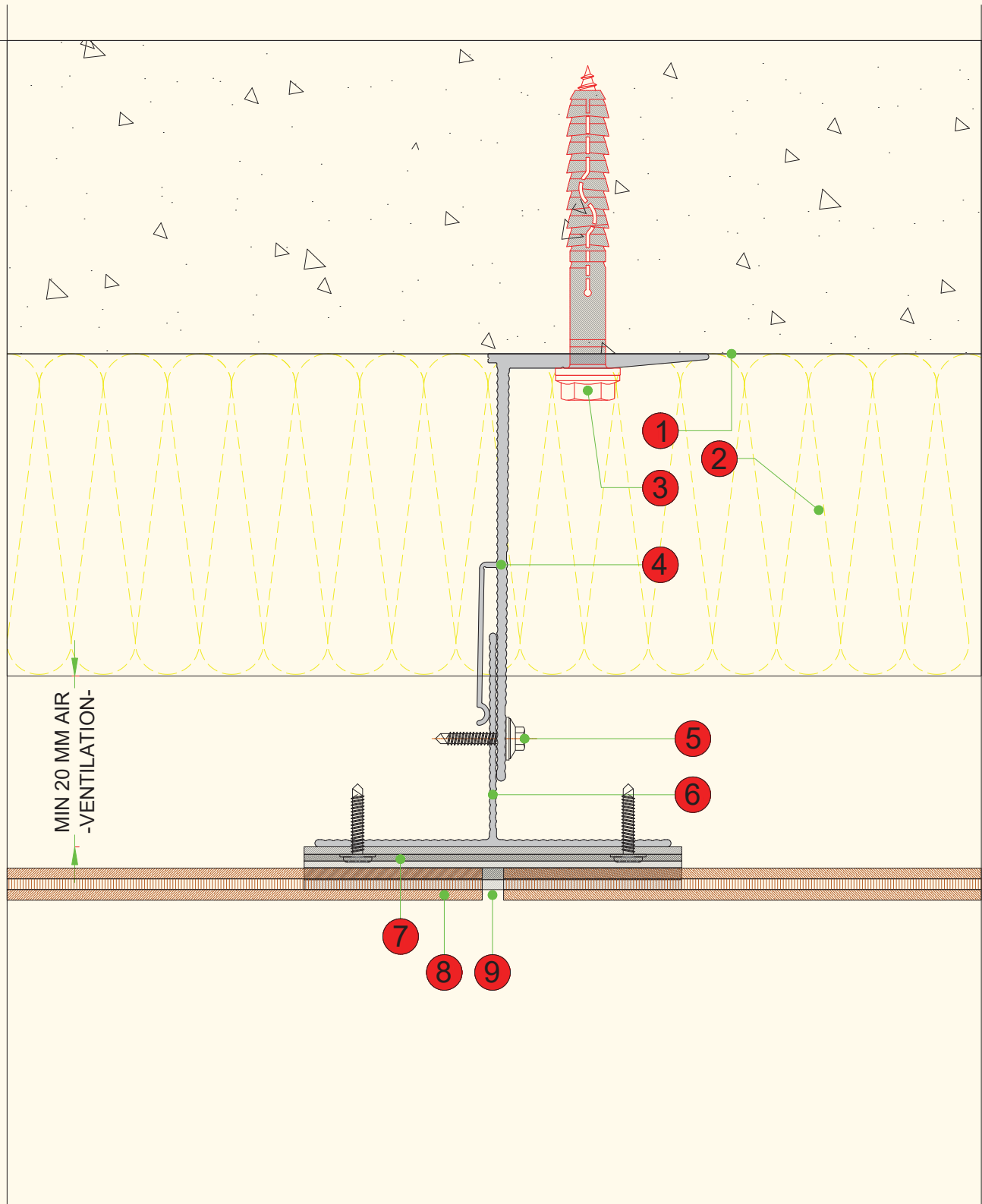

Sl. No.	Accessories	Concealed Fixing 'J Clip' System	D7 - Horizontal section
1	EXISTING CONSTRUCTION		
2	INSULATION		
3	ANCHOR FASTENER		
4	ADJUSTABLE L BRACKET		
5	SELF TAPPING SCREW		
6	VERTICAL T PROFILE		
7	HORIZONTAL 'J' PROFILE		
8	<b>MERINO</b> ARMOUR EWC		
9	AIR CIRCULATION GAP		

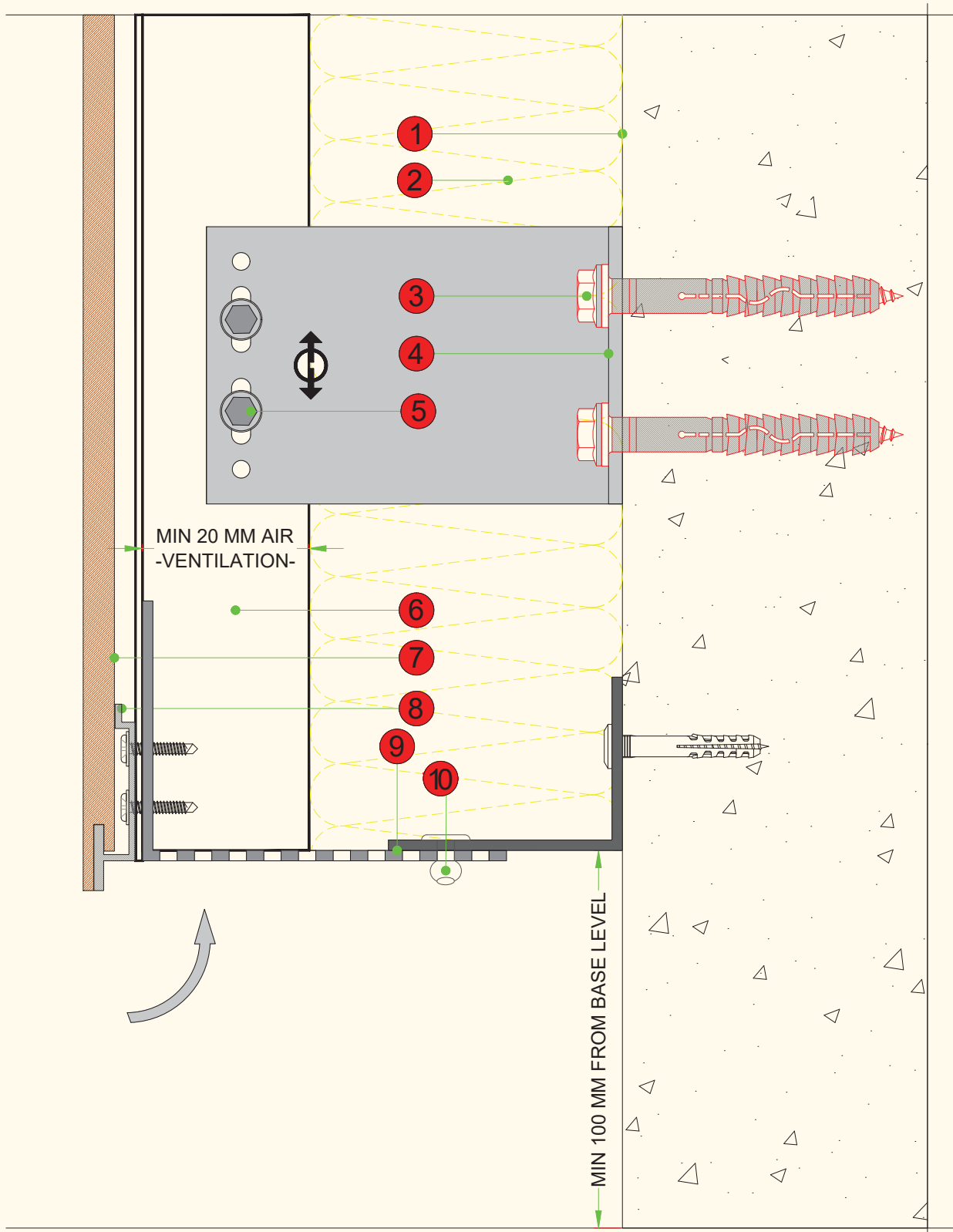

Sl. No.	Accessories	Concealed Fixing 'J Clip' System	D8 - Base details
1	EXISTING CONSTRUCTION		
2	INSULATION		
3	ANCHOR FASTENER		
4	ADJUSTABLE L BRACKET		
5	SELF TAPPING SCREW		
6	VERTICAL L PROFILE		
7	<b>MERINO</b> ARMOUR EWC		
8	HORIZONTAL 'J' PROFILE		
9	ANCHOR FASTENER		
10	L PROFILE / BRACKET OR RAIL		
11	AIR FLOW PROFILE / RAIL		



Sl. No.	Accessories	Concealed Fixing 'J Clip' System	D9 - Internal Corner
1	EXISTING CONSTRUCTION		
2	INSULATION		
3	ANCHOR FASTENER		
4	ADJUSTABLE L BRACKET		
5	SELF TAPPING SCREW		
6	CORNER L PROFILE		
7	VERTICAL L PROFILE		
8	<b>MERINO</b> ARMOUR EWC		
9	HORIZONTAL 'J' PROFILE		

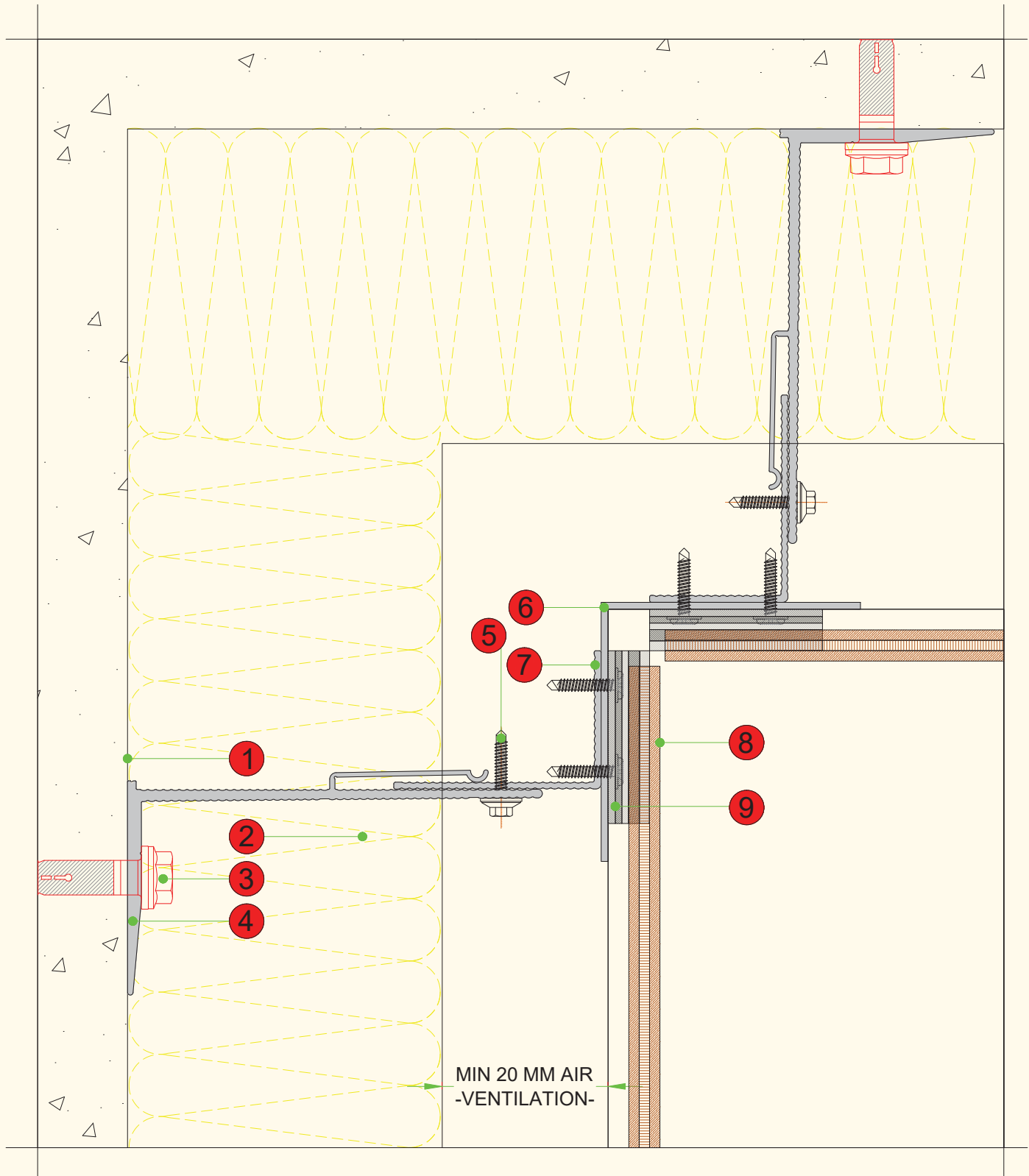

# 4 - CONCEALED FIXING UNDERCUT SYSTEM

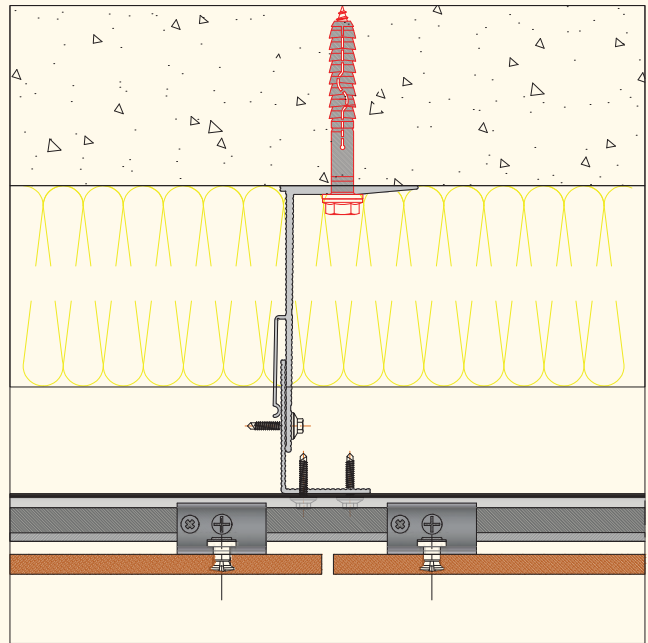
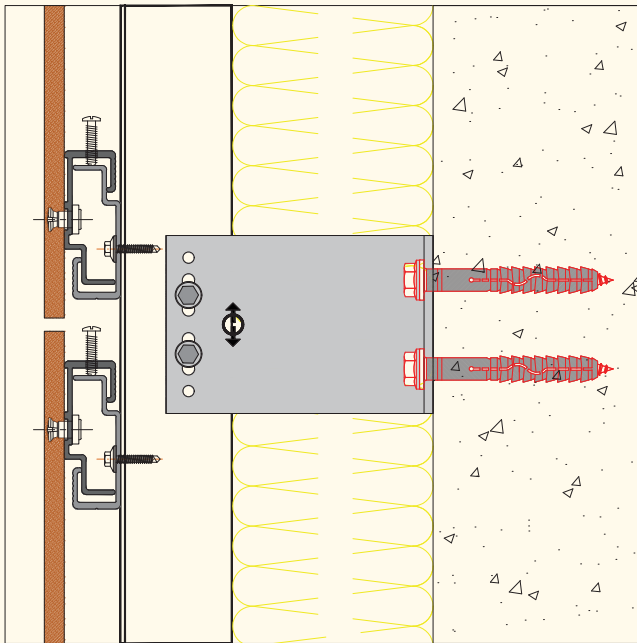
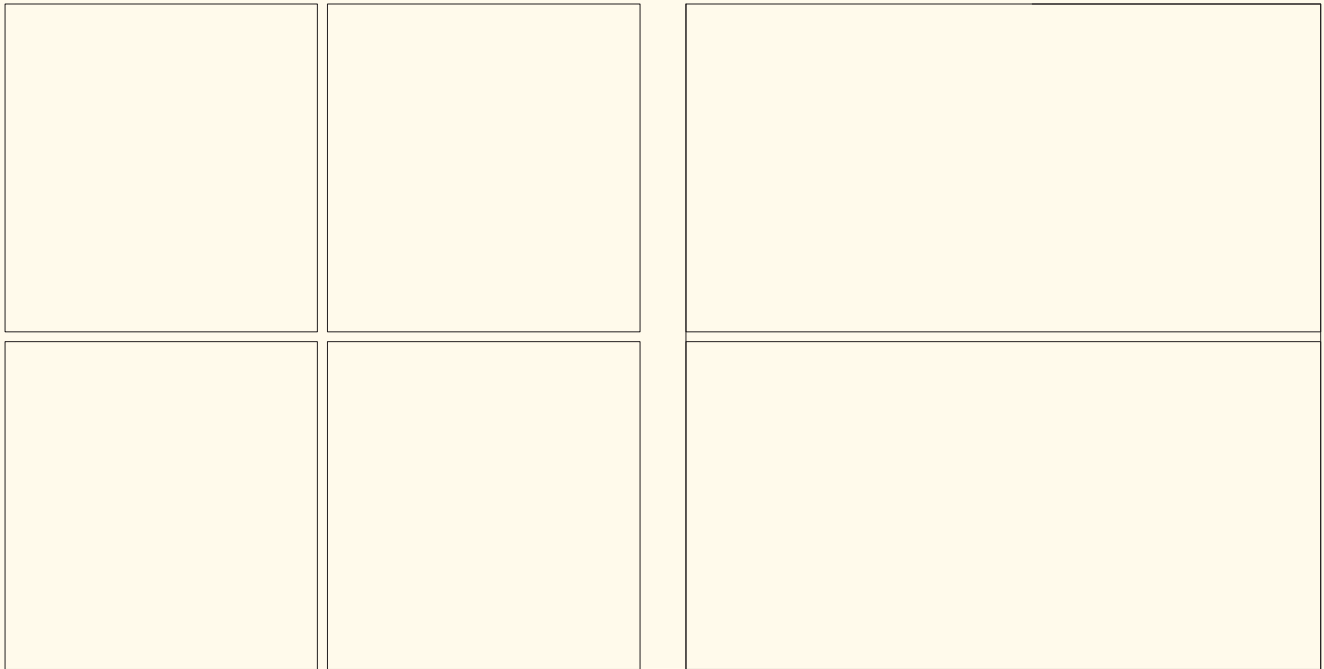





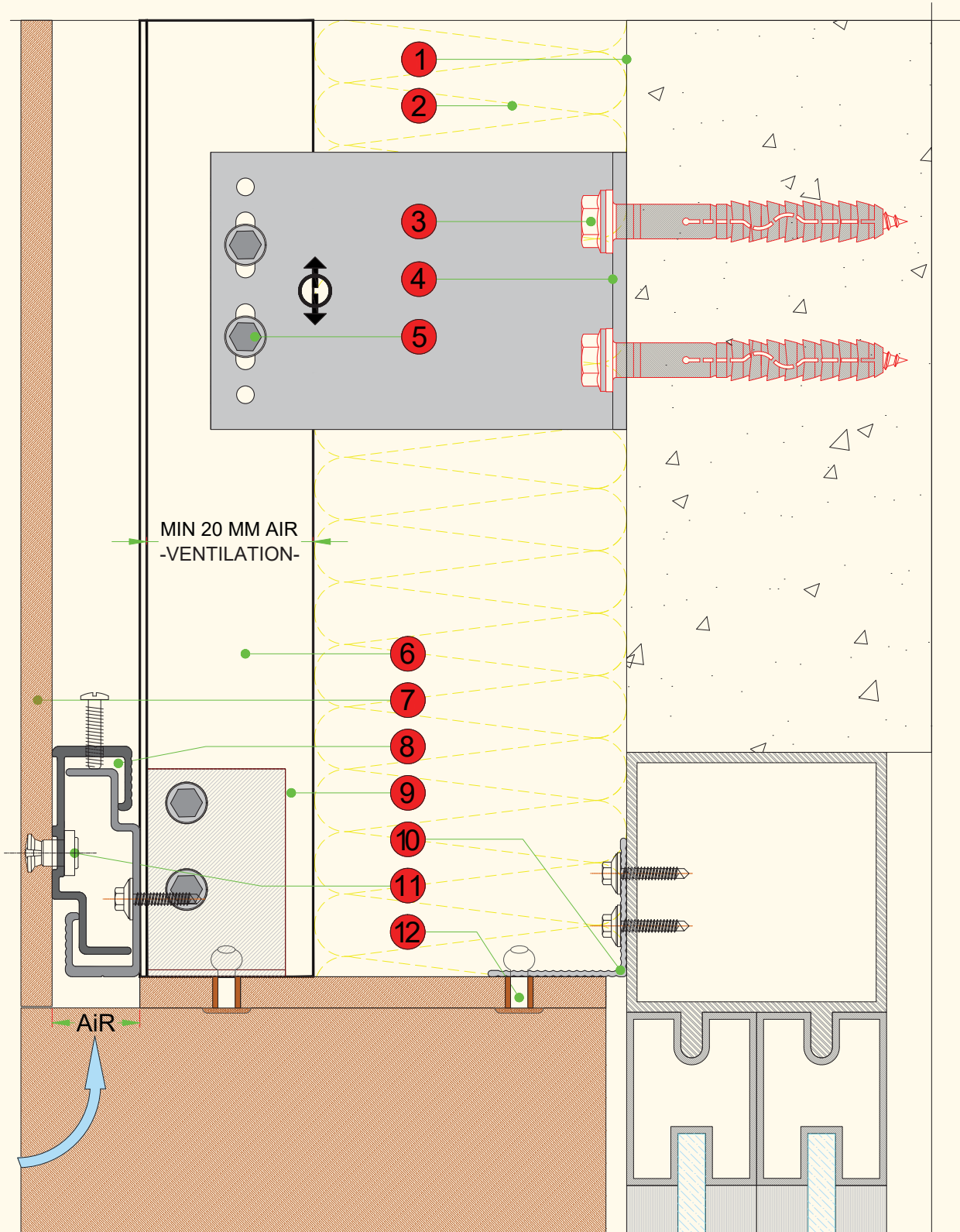

Sl. No.	Accessories	Concealed Fixing 'Undercut' System	D1 - Window Lintel
1	EXISTING CONSTRUCTION		
2	INSULATION		
3	ANCHOR FASTENER		
4	ADJUSTABLE L BRACKET		
5	SELF TAPPING SCREW		
6	VERTICAL PROFILE		
7	<b>MERINO</b> ARMOUR EWC		
8	MALE - FEMALE 'J' PROFILES		
9 - 10	L BRACKET / ANGLE		
11	UNDERCUT ANCHOR		
12	<b>MERINO</b> POP BLIND RIVET		





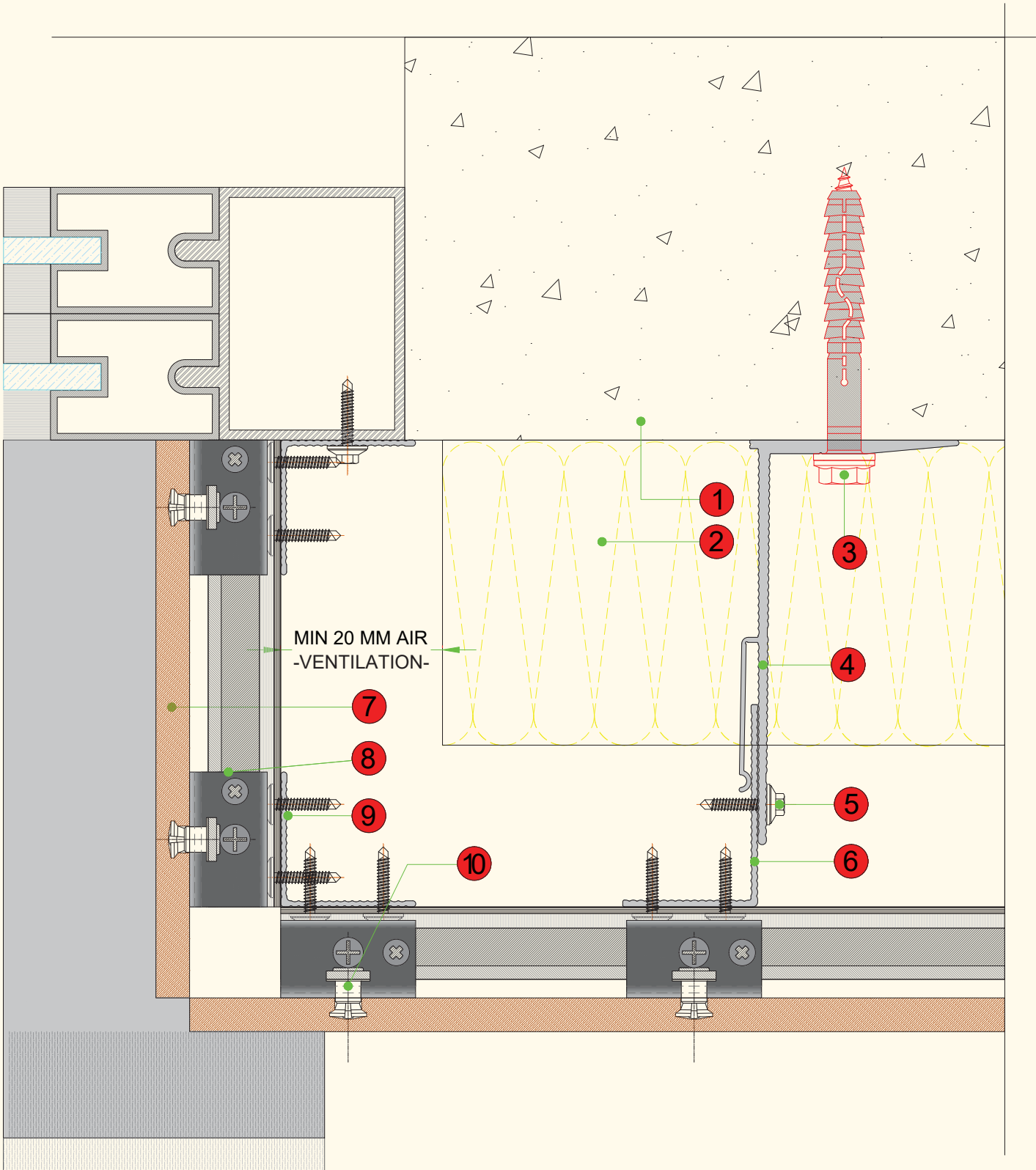

Sl. No.	Accessories	Concealed Fixing 'Undercut' System	D2 - Window Reveal
1	EXISTING CONSTRUCTION		
2	INSULATION		
3	ANCHOR FASTENER		
4	ADJUSTABLE L BRACKET		
5	SELF TAPPING SCREW		
6	VERTICAL L PROFILE		
7	<b>MERINO</b> ARMOUR EWC		
8	MALE - FEMALE 'J' PROFILES		
9	L PROFILE		
10	UNDERCUT ANCHOR		

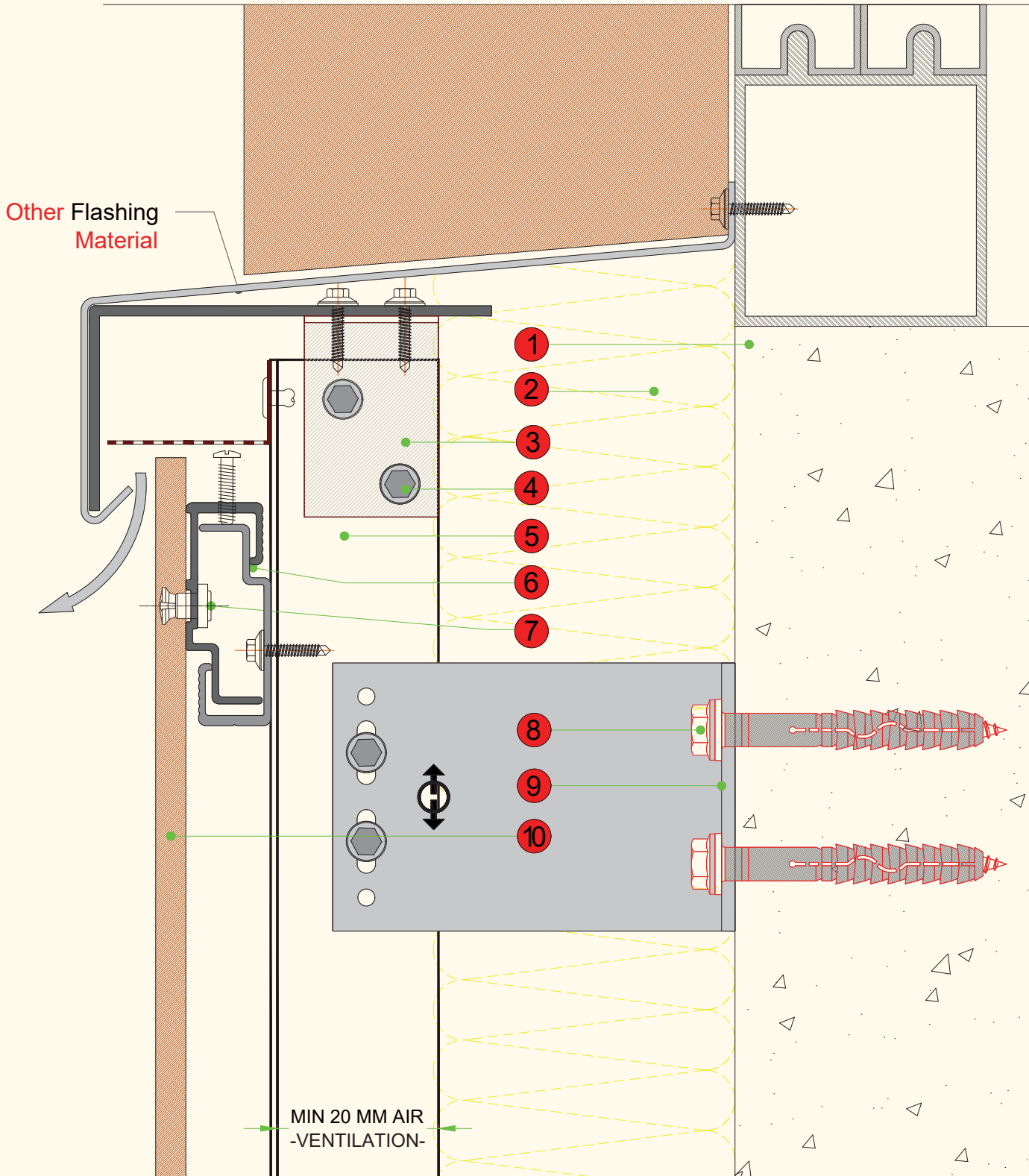

Sl. No.	Accessories	Concealed Fixing 'Undercut' System	D3 - Window sill
1	EXISTING CONSTRUCTION		
2	INSULATION		
3	L BRACKET/ANGLE		
4	SELF TAPPING SCREW		
5	VERTICAL L PROFILE		
6	MALE - FEMALE 'J' PROFILES		
7	UNDERCUT ANCHOR		
8	ANCHOR FASTENER		
9	ADJUSTABLE L BRACKET		
10	<b>MERINO</b> ARMOUR EWC		



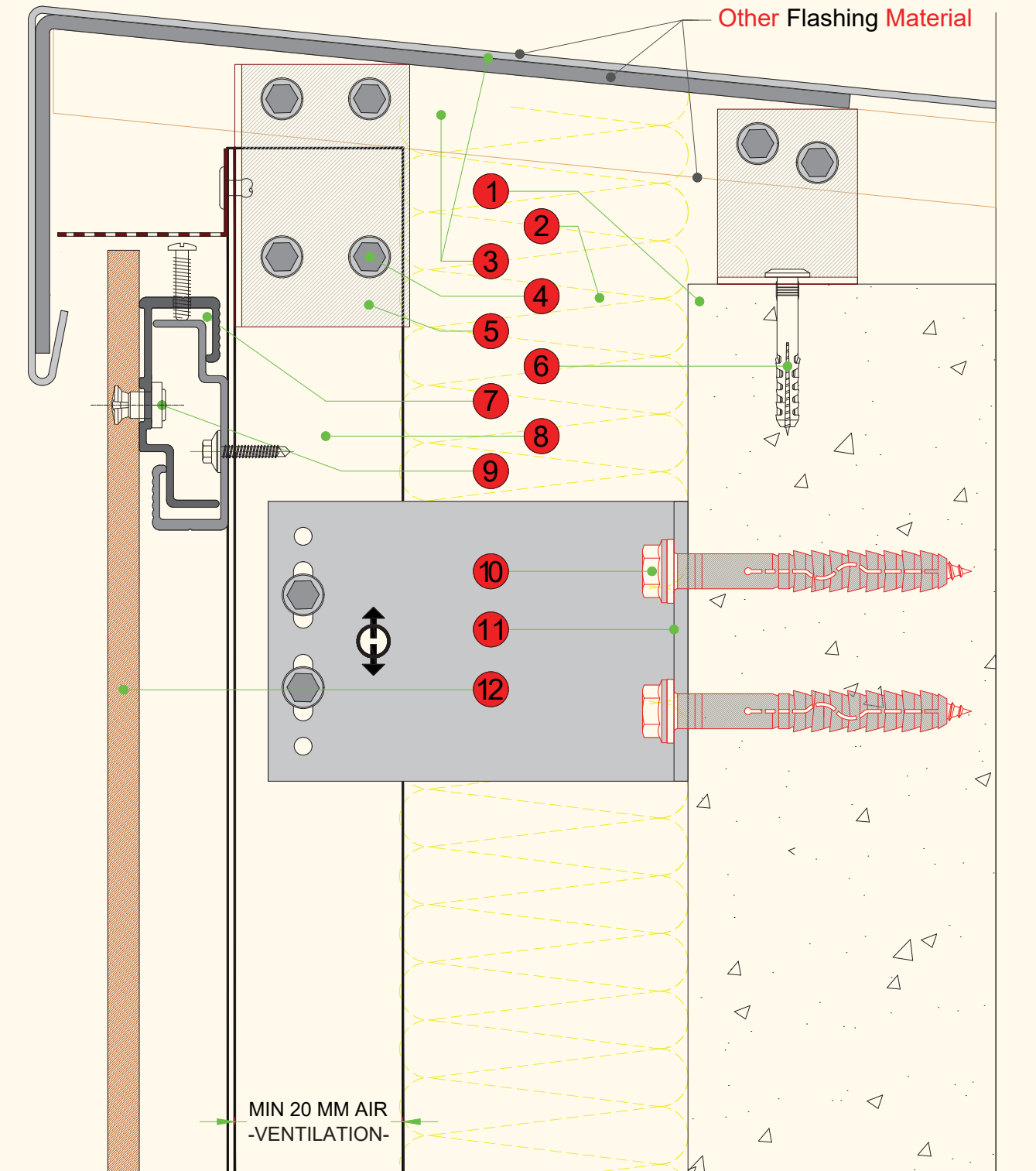

Sl. No.	Accessories	Concealed Fixing 'Undercut' System	D4 - Head Details
1	EXISTING CONSTRUCTION		
2	INSULATION		
3	FLASHING BY OTHERS		
4	SELF TAPPING SCREW		
5	L BRACKET / ANGLE		
6	ANCHOR FASTENER		
7	MALE - FEMALE 'J' PROFILES		
8	VERTICAL PROFILE		
9	UNDERCUT ANCHOR		
10	ANCHOR FASTENER		
11	ADJUSTABLE L BRACKET		





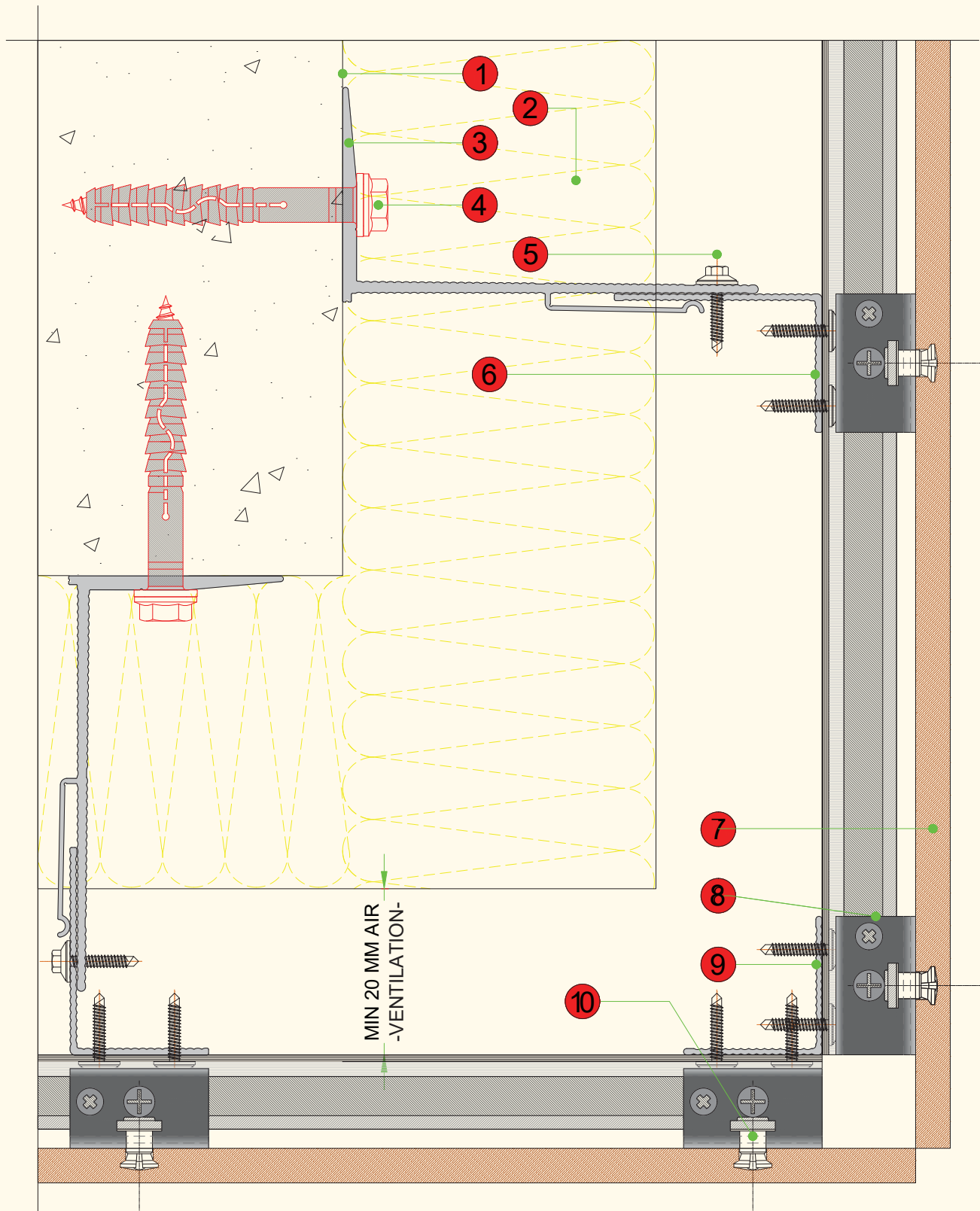

Sl. No.	Accessories	Concealed Fixing 'Undercut' System	D5 - External Corner
1	EXISTING CONSTRUCTION		
2	INSULATION		
3	ADJUSTABLE L BRACKET		
4	ANCHOR FASTENER		
5	SELF TAPPING SCREW		
6	VERTICAL L PROFILE		
7	<b>MERINO</b> ARMOUR EWC		
8	MALE - FEMALE 'J' PROFILES		
9	L PROFILE		
10	UNDERCUT ANCHOR		



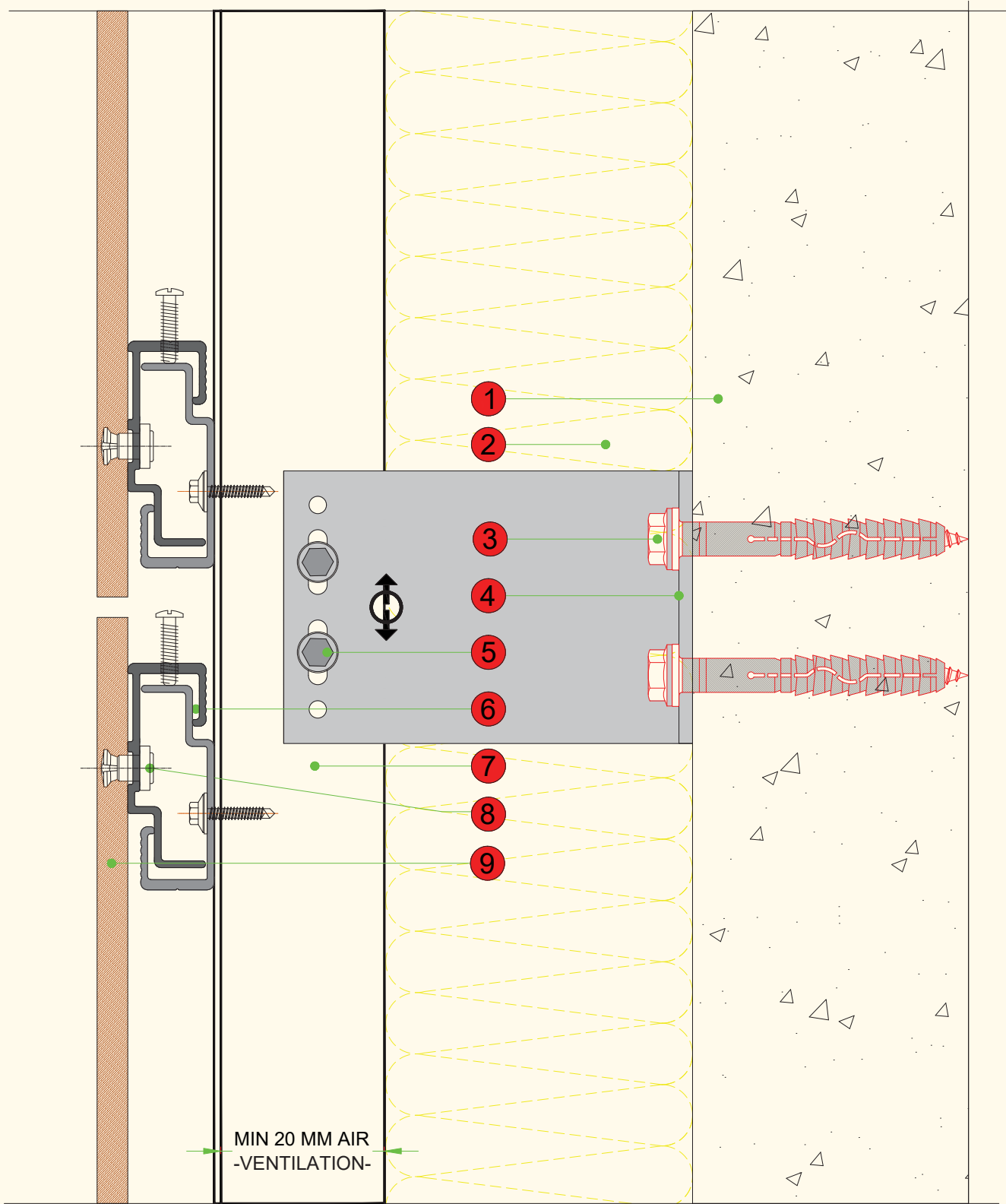

Sl. No.	Accessories	Concealed Fixing 'Undercut' System	D6 - Vertical section
1	EXISTING CONSTRUCTION		
2	INSULATION		
3	ANCHOR FASTENER		
4	ADJUSTABLE L BRACKET		
5	SELF TAPPING SCREW		
6	MALE - FEMALE 'J' PROFILES		
7	VERTICAL L PROFILE		
8	UNDERCUT ANCHOR		
9	<b>MERINO</b> ARMOUR EWC		





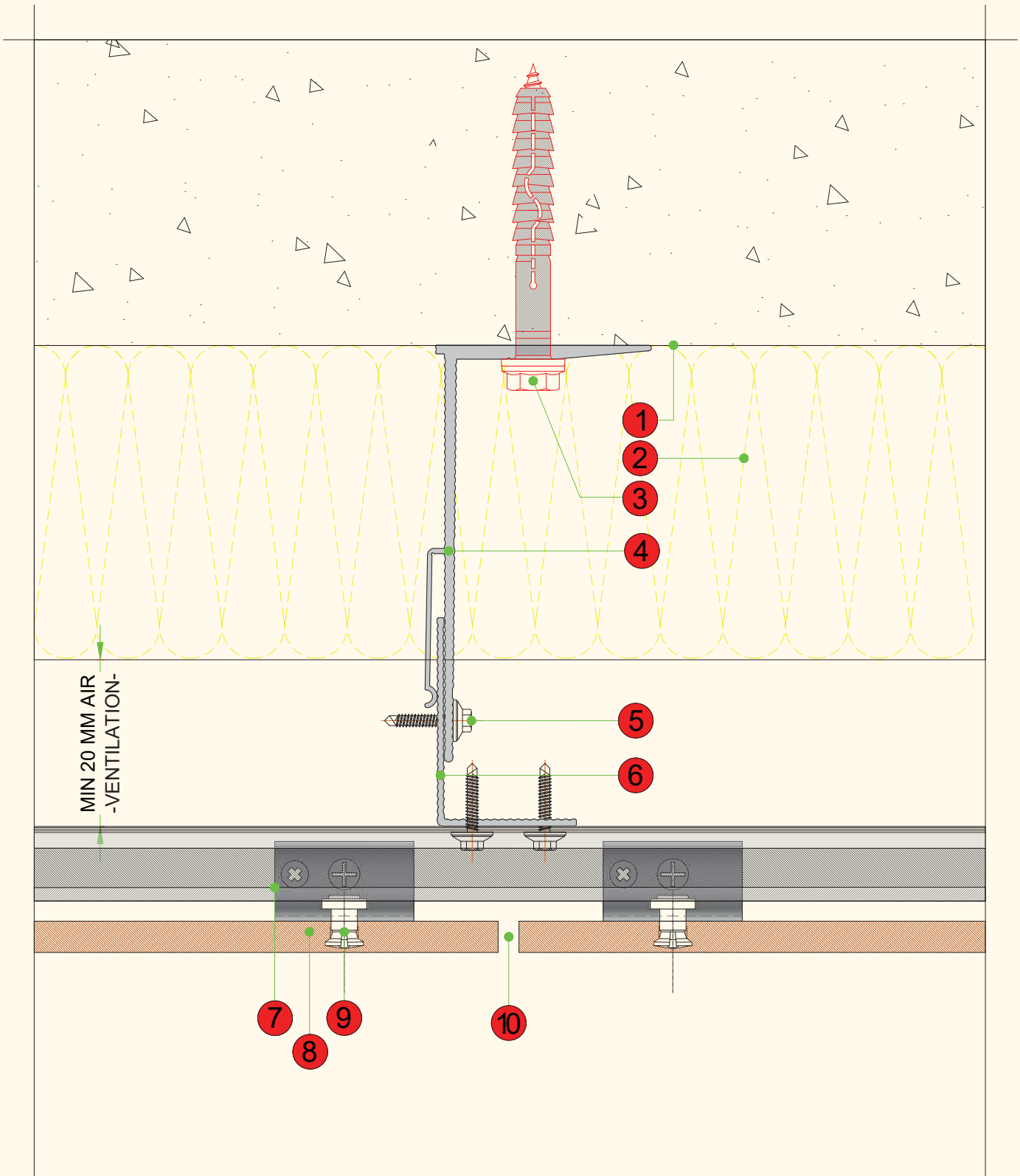

Sl. No.	Accessories	Concealed Fixing 'Undercut' System	D7 - Horizontal section
1	EXISTING CONSTRUCTION		
2	INSULATION		
3	ANCHOR FASTENER		
4	ADJUSTABLE L BRACKET		
5	SELF TAPPING SCREW		
6	VERTICAL T PROFILE		
7	MALE - FEMALE 'J' PROFILES		
8	<b>MERINO</b> ARMOUR EWC		
9	UNDERCUT ANCHOR		
10	AIR CIRCULATION GAP		

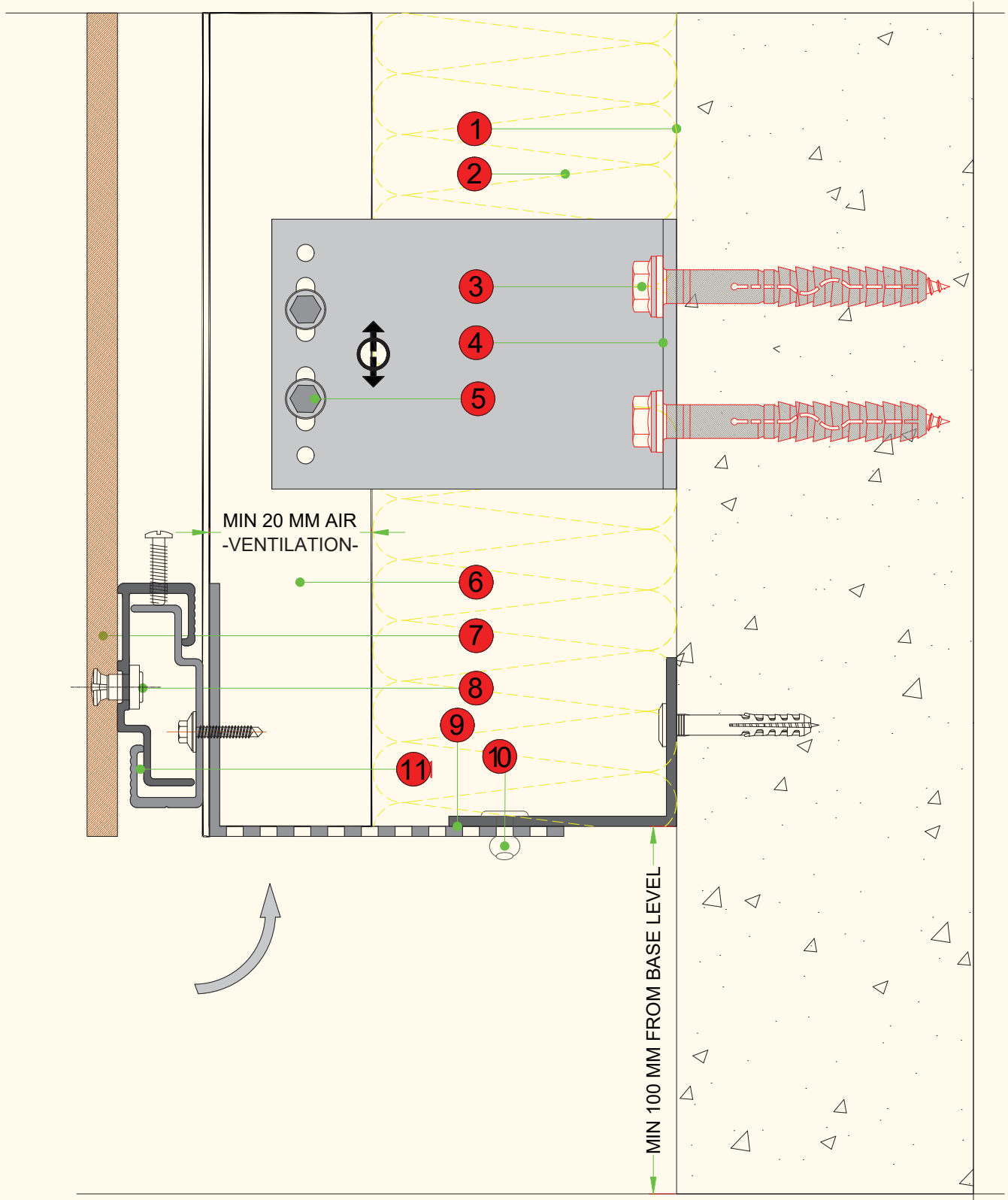

Sl. No.	Accessories	Concealed Fixing 'Undercut' System	D8 - Base details
1	EXISTING CONSTRUCTION		
2	INSULATION		
3	ANCHOR FASTENER		
4	ADJUSTABLE L BRACKET		
5	SELF TAPPING SCREW		
6	VERTICAL L PROFILE		
7	<b>MERINO</b> ARMOUR EWC		
8	UNDERCUT ANCHOR		
9	PERFORATED PROFILES		
10	POP BLIND RIVET		
11	MALE - FEMALE 'J' PROFILES		



Sl. No.	Accessories	Concealed Fixing 'Undercut' System	D9 - Internal Corner
1	EXISTING CONSTRUCTION		
2	INSULATION		
3	ANCHOR FASTENER		
4	ADJUSTABLE L BRACKET		
5	SELF TAPPING SCREW		
6	CORNER L PROFILE		
7	VERTICAL L PROFILE		
8	<b>MERINO</b> ARMOUR EWC		
9	MALE - FEMALE 'J' PROFILES		
10	UNDERCUT ANCHOR		

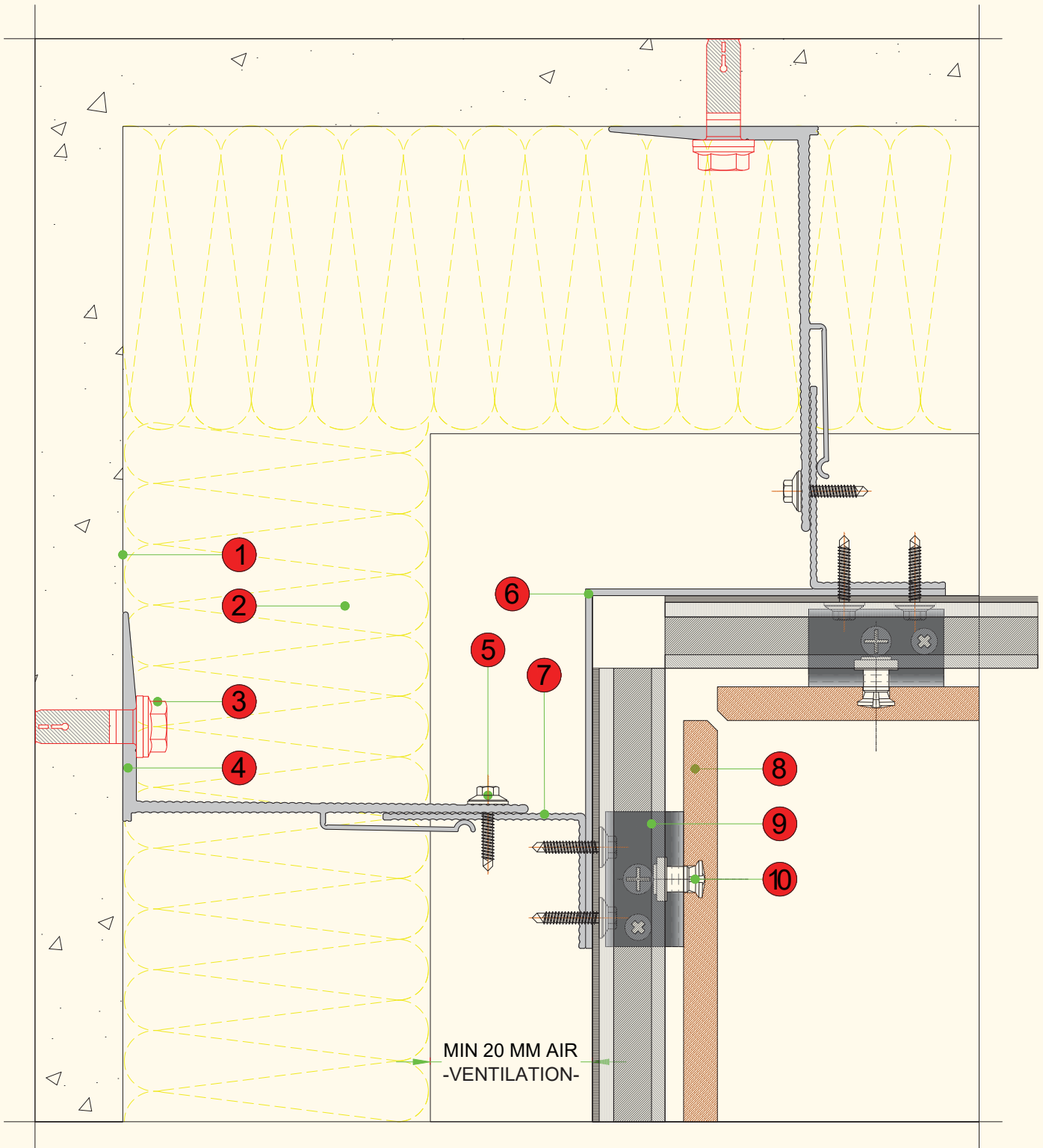

## CARE AND MAINTENANCE

### Important guidelines to care for the Panel surface

- Panels don't corrode and therefore require low maintenance.
- Panels can be cleaned with a mild, non-abrasive detergent dissolved in water using a sponge and/or a soft cloth. After cleaning rinse thoroughly with water. It is recommended to buffer the panels dry after cleaning, to avoid leaving watermarks.
- Avoid excessive rubbing/pressure or using abrasive materials that could cause abrasion marks or scratches.
- A high-pressure cleaner may be used provided that the pressure does not exceed 100 bar and the spray distance is 50 cm.
- Using a dirt scraper is not advisable on the surface.
- Panel's chemical resistant nature and closed structure do not allow paint in spray cans, various inks, emulsion paints, lipstick, or pastel paints to adhere to the surface and penetrate to the core. Panels do not require any anti-graffiti treatment.
- Panel surface can be disinfected using normal sanitizing reagents. Regular disinfecting practices will help to maintain hygiene and clean surface. During the disinfecting process damp-wipe on all horizontal, vertical, and contact surfaces with a cotton cloth saturated (microfiber) and a disinfectant-detergent solution. The use of ethanol and isopropyl alcohol is recommended to disinfect the surface free of various viruses and microorganisms. Use EPA registered disinfectant-detergent in recommended concentration for good disinfecting practices. Avoid mixing chemical products during the process.
- Extended exposure of the decorative surface to bleach will cause discoloration. Always wash the decorative surface with clean water after cleaning and wipe immediately using a dry cotton cloth
- Always ensure to use a product that is not past its expiration date for cleaning and sanitation.
- If the surface of the panel is coated with graffiti, even in several coats, it can be removed using specific products for removing paint from plastic materials, which do not harm the original appearance of the surface. These products are available commercially in the form of gel, liquid, or spray. Most of these can also be used to remove stubborn dirt such as grease, algae, etc. Follow the product supplier's instructions and after treatment never forget to rinse the surface thoroughly with water. We suggest the use of the graffiti remover GR1 by 3M.
- In case of use of any cleaner, we recommend testing it over a small hidden area of the panel first to evaluate the result and to be sure the product is suitable for the panel.

## LIMITED WARRANTY

Merino panels will continue to possess the properties as per requirement of EN 438-part-6 for a period indicated below from the date of delivery of the product to the buyer.

Merino Super clad has warranty of 10 years.

Warranty will be valid when installation will be done according to Merino Installation Guidelines only in supervision of Merino technical team.

LIMITED PRODUCT WARRANTY - Merino Industries Ltd. warrants that under normal use of Merino panels, it will conform to the properties as per specification of EN 438-part-6, from the date of delivery of the product to the first consumer purchaser, subject to following conditions:

- (a) Slight loss of brightness or homogeneous variation in colour taking place in course of time of use is acceptable as per EN 438 Part 6
- (b) The warranty shall be non-transferable and any resale or transfer of any kind whatsoever, of the product by the first consumer purchaser shall render the warranty void.
- (c) This warranty shall not cover any damage or deviation from the standard EN 438 Part 6 set forth for Panel properties if it is caused by:
  - (d) Accidents, abuse or misuse
  - (e) Exposure to extreme temperatures
  - (f) Improper fabrication or installation; or (iv) improper maintenance, and Merino shall have the sole and absolute right to determine the reason for such damage or deviation.
- (g) This warranty shall be void, subject to other terms and conditions contained herein, upon non-production of the original warranty document, duly sealed and stamped on the date of purchase by Merino Industries Ltd. or by any of its authorised dealers.
- (h) Under no circumstances shall Merino Industries Ltd. be liable for any loss or damage arising from the purchase, use or inability to use the product or for any special, indirect, incidental or consequential damages.
- (i) In case of any dispute or differences which arise out of these warranty terms, the same shall be exclusively subject to the jurisdiction of the Courts of Law in Kolkata, India.
- (j) These terms of warranty shall be deemed to have been accepted upon purchase of the product by the first consumer purchaser.

For terms & conditions visit: [www.merinolaminates.com/en/limitedwarranty](http://www.merinolaminates.com/en/limitedwarranty)









## FEEDBACK

A series of horizontal dashed lines for writing feedback.







## Contact us

### MARKETING OFFICE

**New Delhi:** 70, KLJ Complex, 2nd Floor,  
Moti Nagar, New Delhi-110015, India  
**P:** 011-45557000, 25107617  
**E:** merinodelhi@merinoindia.com

### REGISTERED OFFICE

5, Alexandra Court, 60/1,  
Chowringhee Road, Kolkata-700020, India  
**P:** 033-22901214/1215  
**E:** merinokol@merinoindia.com

### FACTORY OFFICES

**Hapur:** Village-Achheja, PO-Hapur-245 101  
Dist.Hapur (U .P.), India  
**P:** 0122-3082500, 2308601  
**E:** merinohapur@merinoindia.com  
**(FSC COC certified)**

**Rohad:** 44 KM. Stone, Delhi-Rohtak Road, Rohad,  
Distt. Jhajjar, Haryana-124501, India  
**P:** 01276-221000, 304900  
**E:** merinorohad@merinoindia.com  
**(FSC COC certified)**

**Hosur:** Bagalur Road, Kalahasthipuram Village,  
Hosur Taluk, Distt. Krishnagiri,  
Tamil Nadu-635103, India  
**P:** 04344-293545, 327765  
**E:** merinohosur@merinoindia.com  
**(FSC COC certified)**

**Dahej:** Plot No D2/CH/36, Dahej II Industrial Estate,  
Village Vadala, PO Dahej, District Bharuch,  
Gujarat-392130.  
**P:** +91 - 7283888832

### International Offices

**INDIA:** **P:** +91 11 45557000 **E:** merinodelhi@merinoindia.com  
**AMERICAS:** **P:** +1 305-456-1913 **E:** merinousa@merinoindia.com  
**THAILAND:** **P:** +66 20412188 **E:** merinothailand@merinoindia.com  
**UAE:** **E:** merinouae@merinoindia.com  
**W:** www.merinolaminates.com

### BRANCH OFFICES

**Ahmedabad:** **P:** 079-30075775, 26589511  
**E:** merinoahm@merinoindia.com

**Bengaluru:** **P:** 080-42418000  
**E:** merinobl@merinoindia.com

**Bhubaneswar:** **P:** 0674-3255594, 2597795  
**E:** merinobbsr@merinoindia.com

**Chandigarh:** **P:** 7087001162/63  
**E:** merinochd@merinoindia.com

**Chennai:** **P:** 044-49303333, 49303300,  
**E:** merinoch@merinoindia.com

**Coimbatore:** **P:** 0422-4243333  
**E:** merinocbt@merinoindia.com

**Indore:** **P:** 07312862272

**Ludhiana:** **P:** 7347025195  
**E:** merinoludhiana@merinoindia.com

**New Delhi:** **P:** 011-69015300  
**E:** merinopg@merinoindia.com

**Hyderabad:** **P:** 040-27901103, 1202, 1203, 64590033  
**E:** merinohyd@merinoindia.com

**Jaipur:** **P:** 0141-2206159, 2209505, 2209506  
**E:** merinojaipur@merinoindia.com

**Kochi:** **P:** 0484-2398265, 2397972, 4183301/ 4183333  
**E:** merinokochi@merinoindia.com

**Mumbai:** **P:** 022-67991970/71/72  
**E:** merinomum@merinoindia.com

**Nagpur:** **P:** 0712-2436372, 2457123  
**E:** merinonagpur@merinoindia.com

**Pune:** **P:** 020-24212025, 24214025  
**E:** merinopune@merinoindia.com

**Tinsukia:** **P:** 0374-2338975, 2340975

**Vijayawada:** **M** +91 91 9686446121  
**E:** merinovij@merinoindia.com



FOR ENQUIRY:

- blr.hanex@merinoindia.com
- blrcladding@merinoindia.com

Tel: 080 4241 8000

[www.merinolaminates.com](http://www.merinolaminates.com)



**MERINOEDGE**  
PREMIUM EDGERANDS

**MERINOLAM**  
DECORATIVE LAMINATES

GLOSZ  
*Meister*

**MERINOPLYWOOD**  
PLYWOOD | BLOCKBOARD | FLUSH DOORS

**MERINO**  
ARMOUR  
EXTERNAL  
CLADDING

**MERINOSHURYA**  
LEGALLY TOOKY

**MERINO - PANELS**  
PLYWOOD & PRELAM

**MERINO - BESCO**  
CUBICLES & LOCKERS

**MERINO - HANEX**  
SOLID SURFACES

**myspace**  
Thoughtful furniture solutions

**vegit**



ECONOMY • EXCELLENCE • ETHICS